

Activity Work Book

from

Activities to Share 



Tel: 01227 362858

www.activitiestoshare.co.uk

Contents

- Art to colour and draw
- Dot to dot
- Fill in the blanks
- Easy spelling
- Word search
- Crosswords
- Maths

All created specifically for
individuals with Dementia.

Permission is granted to copy these masters for individual use.

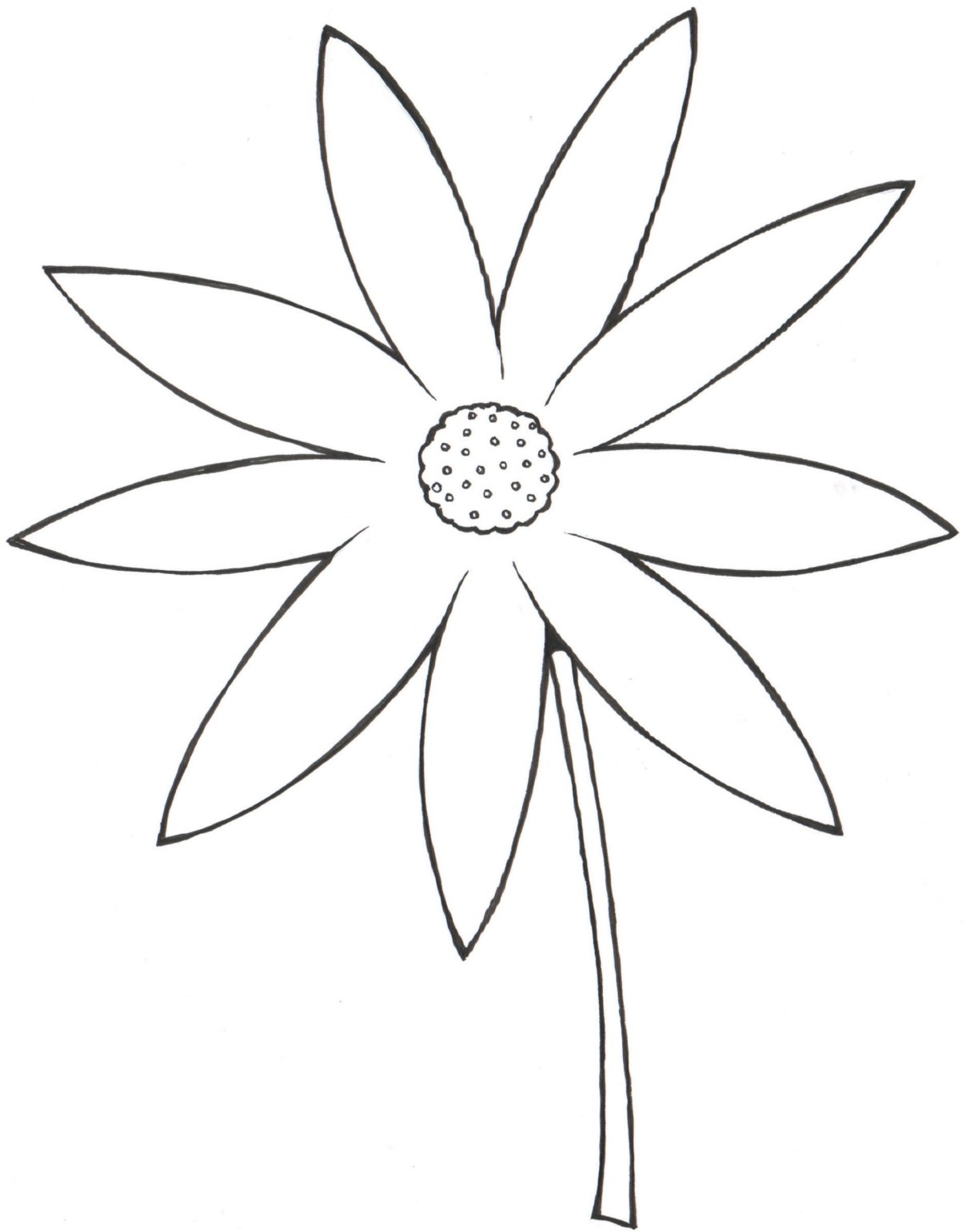



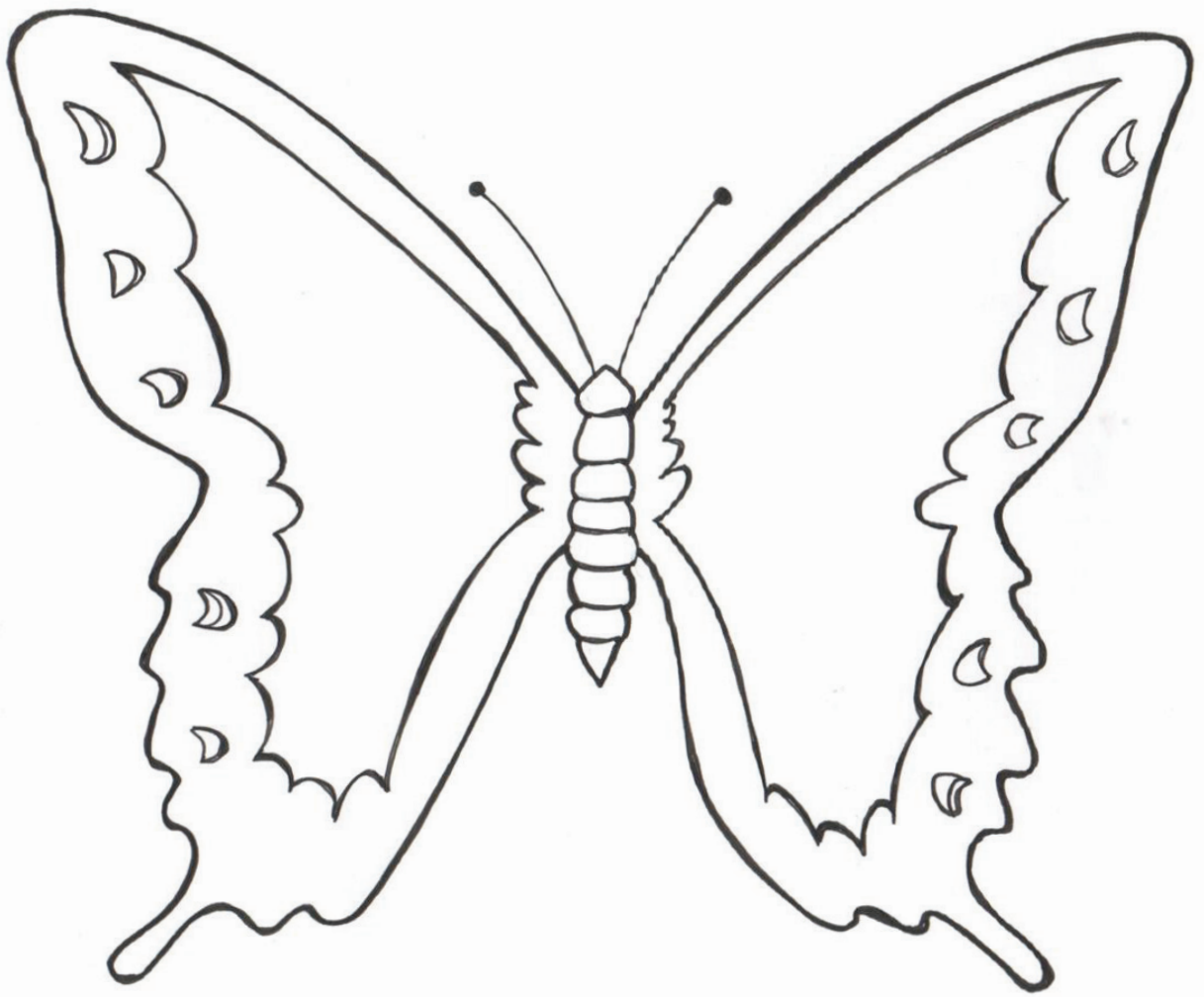

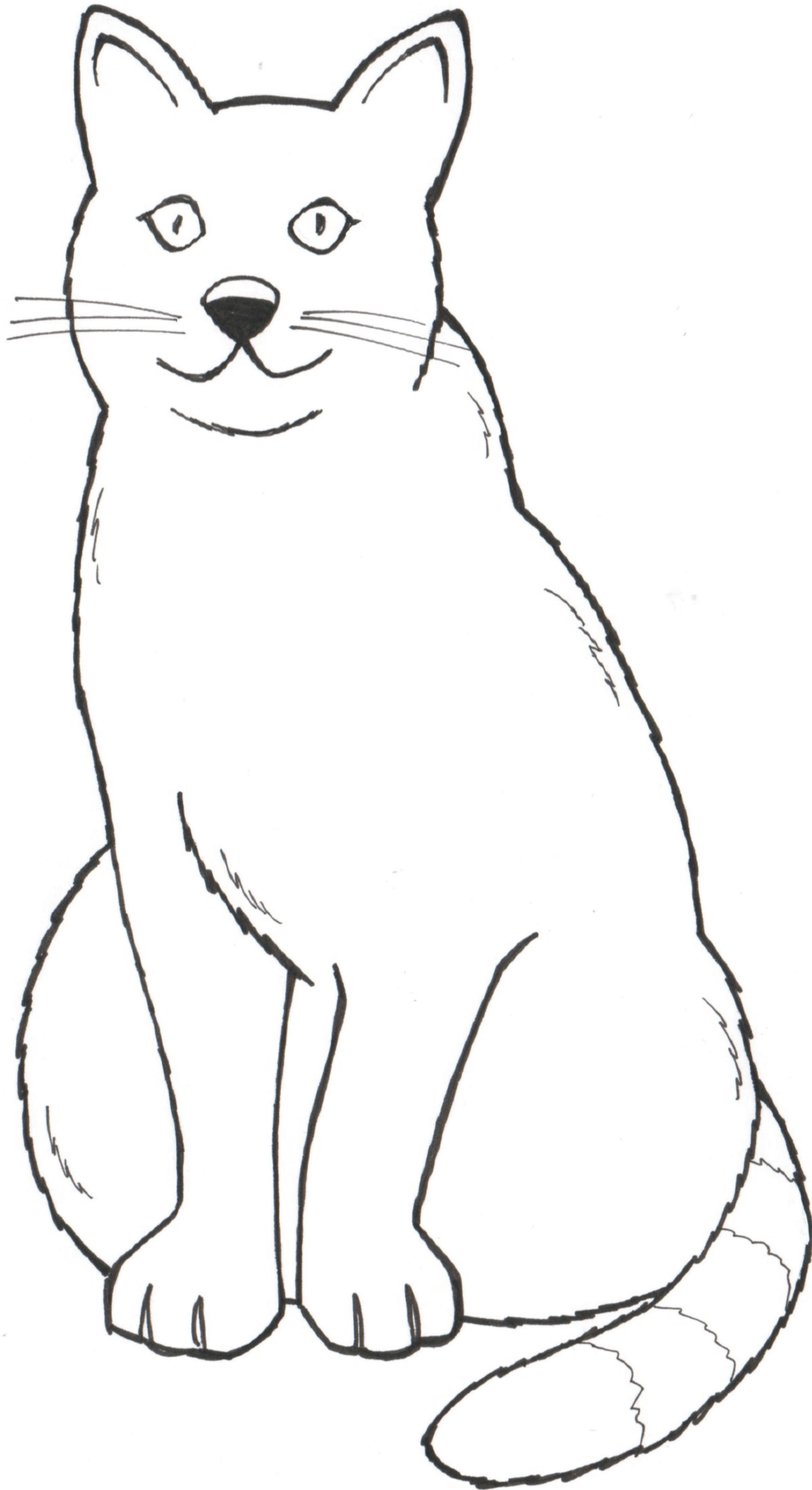



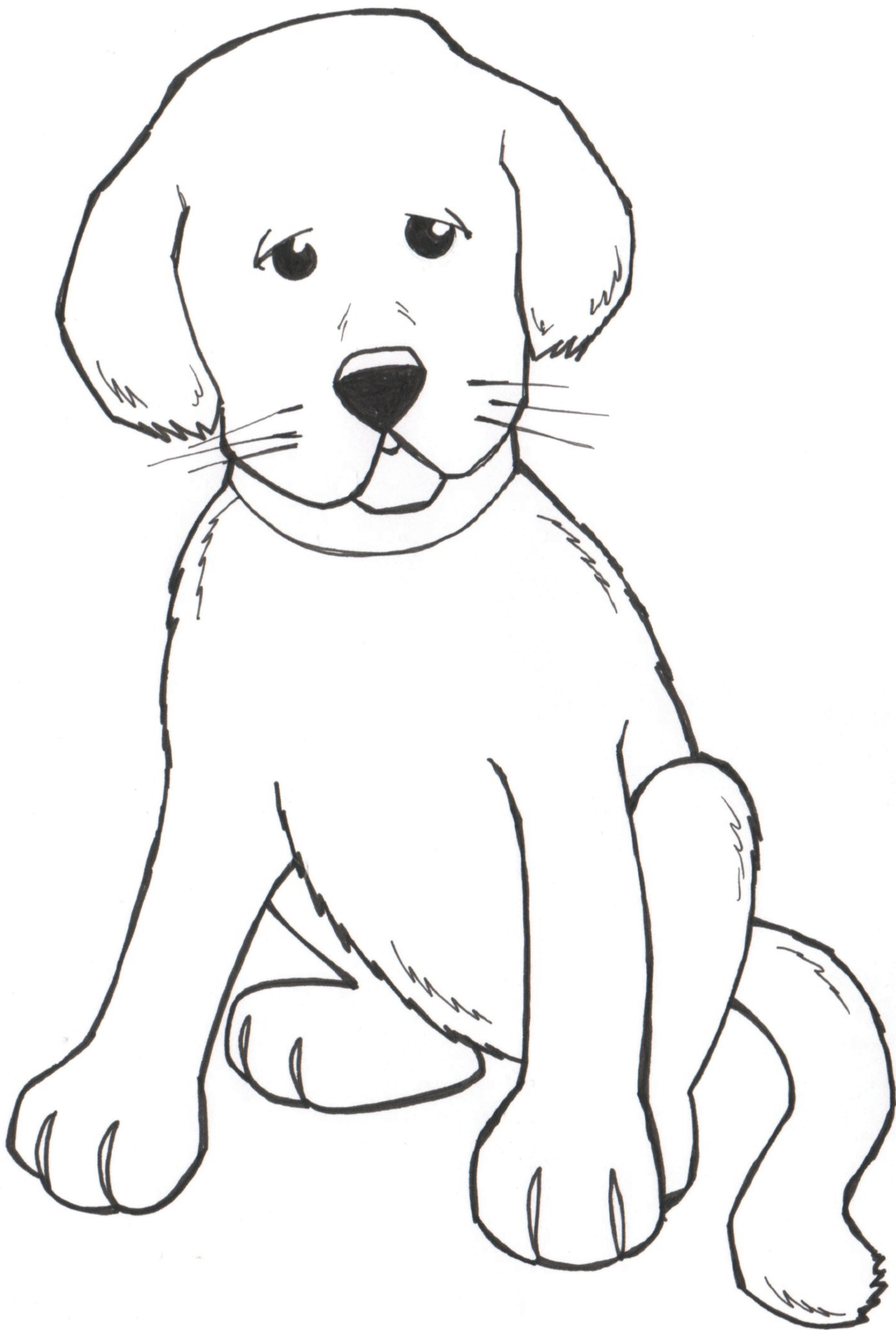





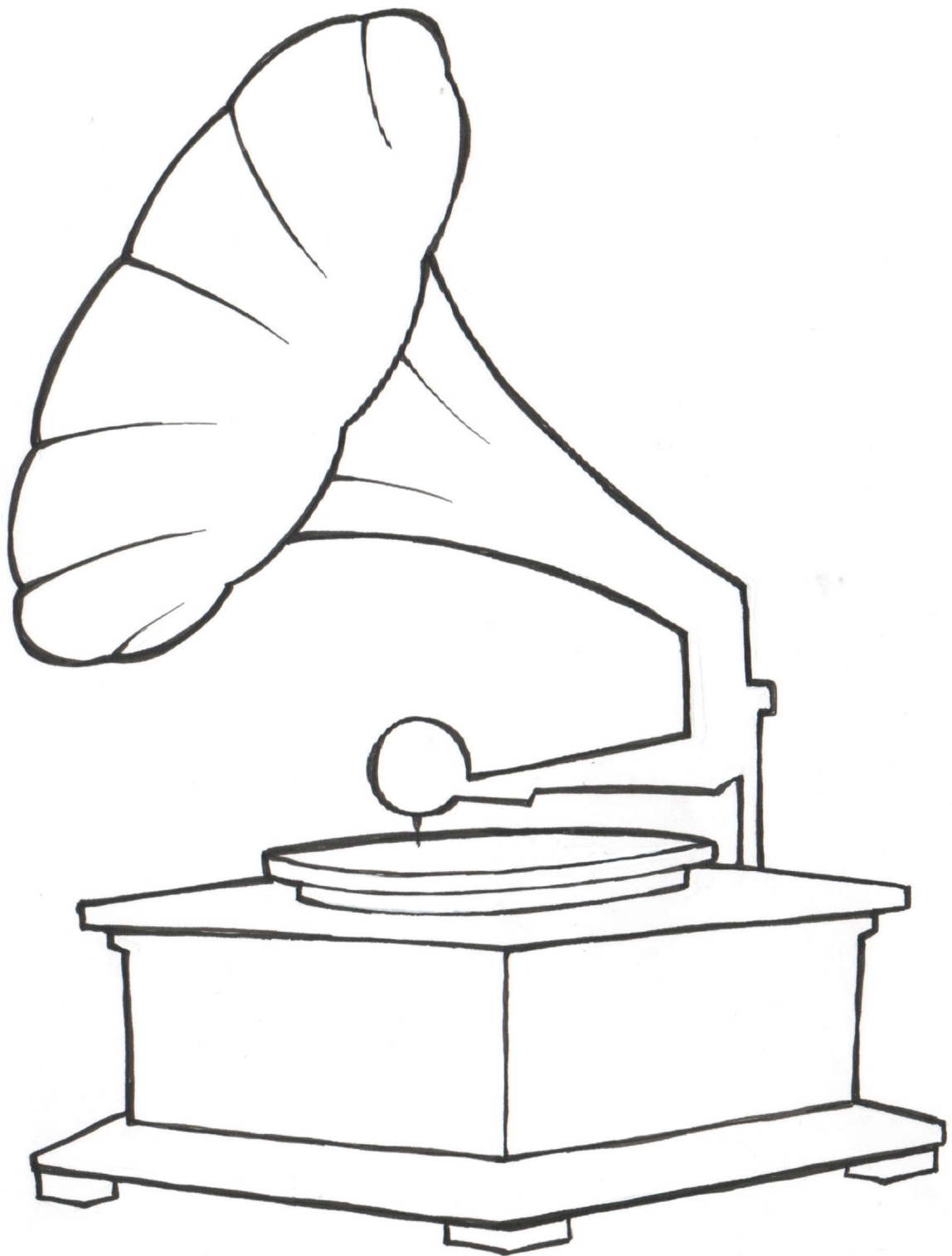

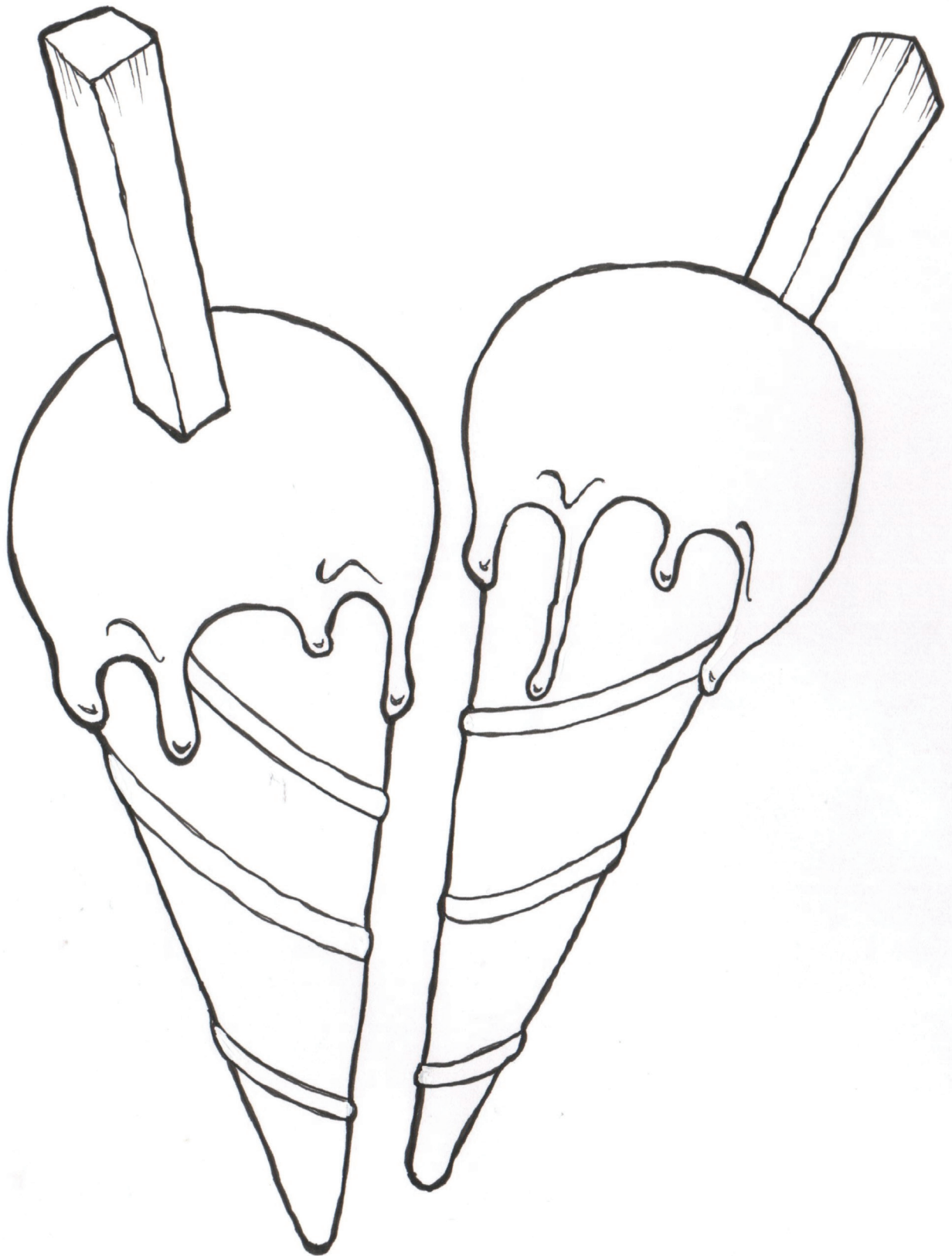

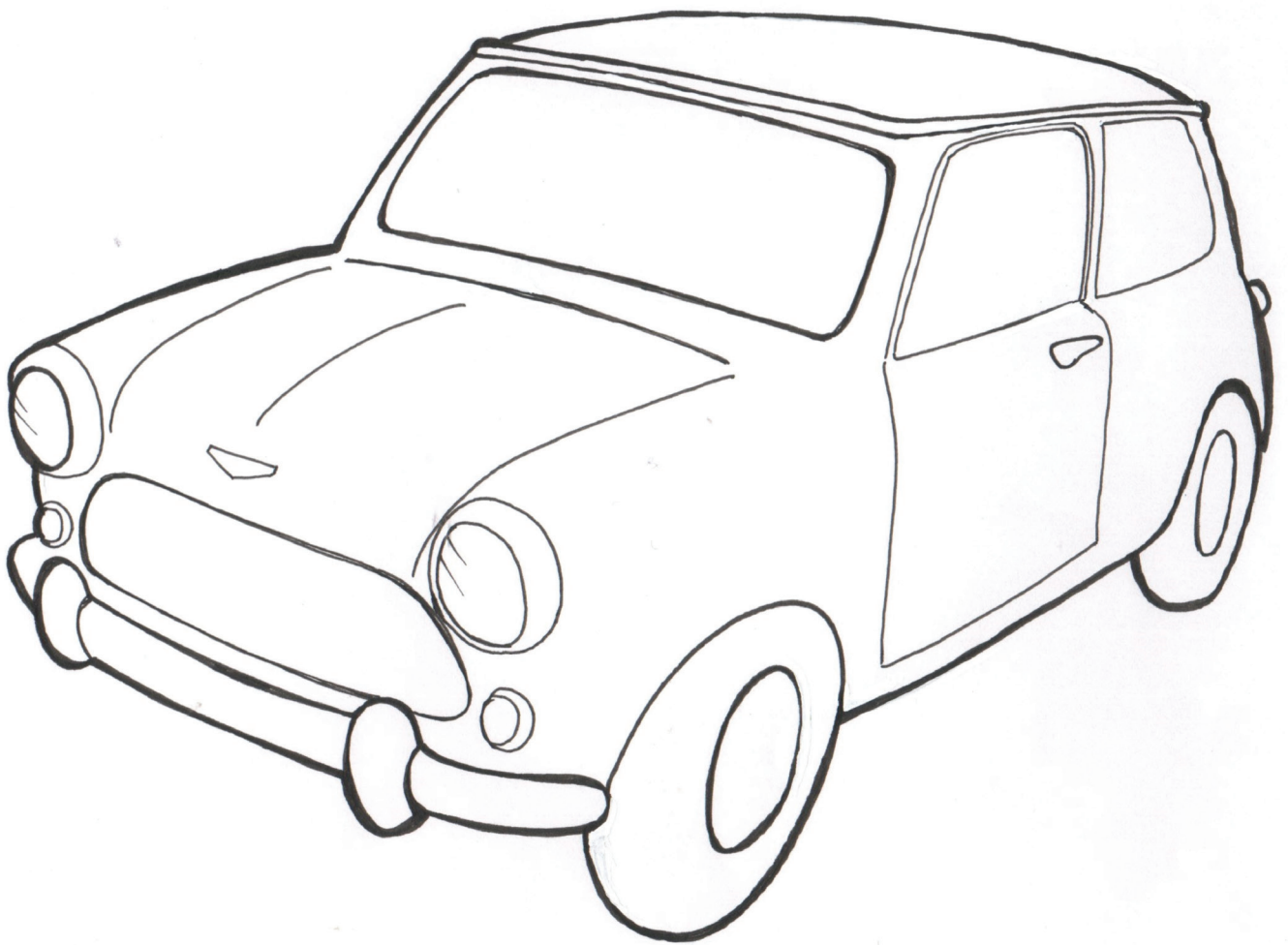

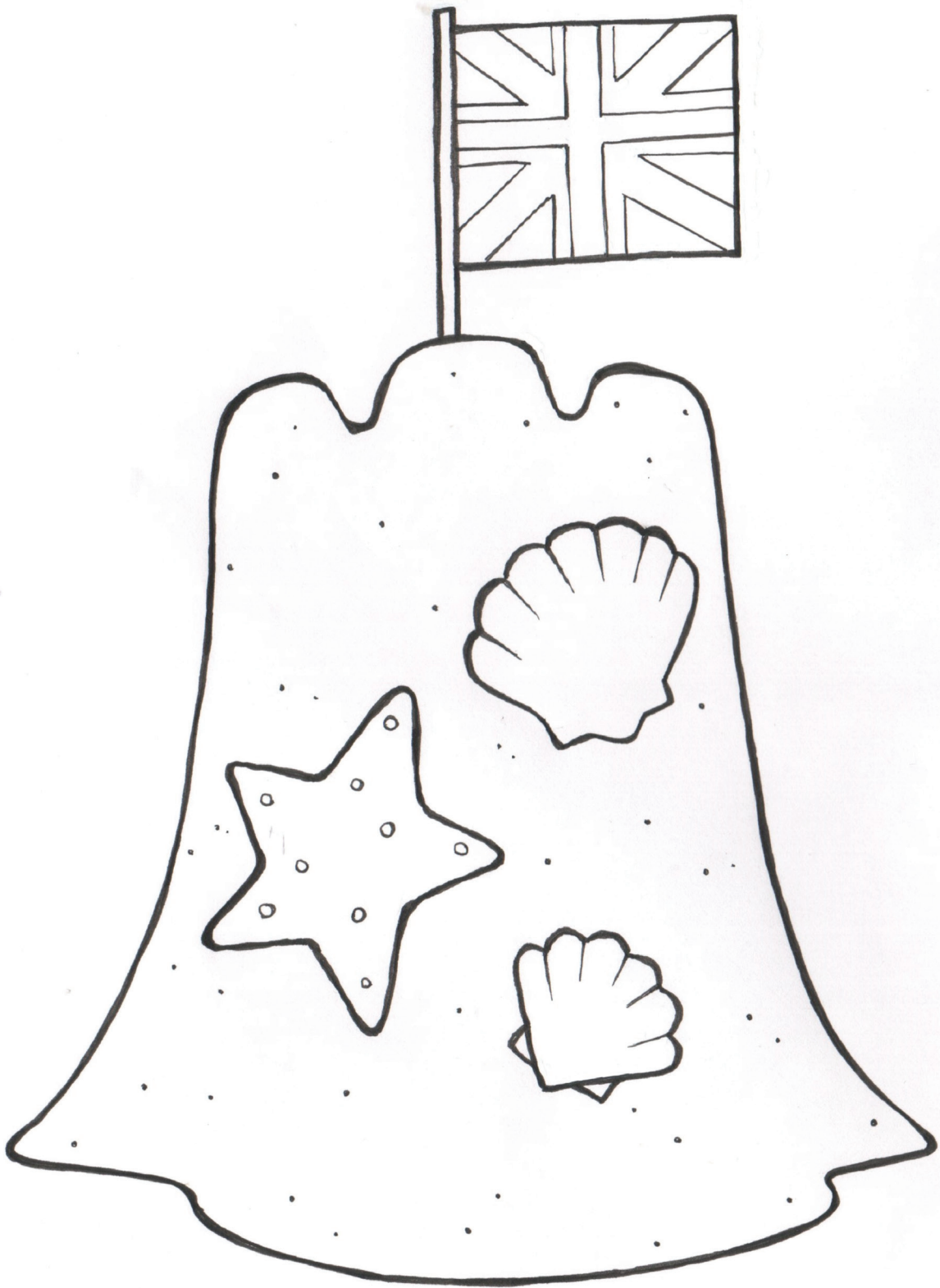

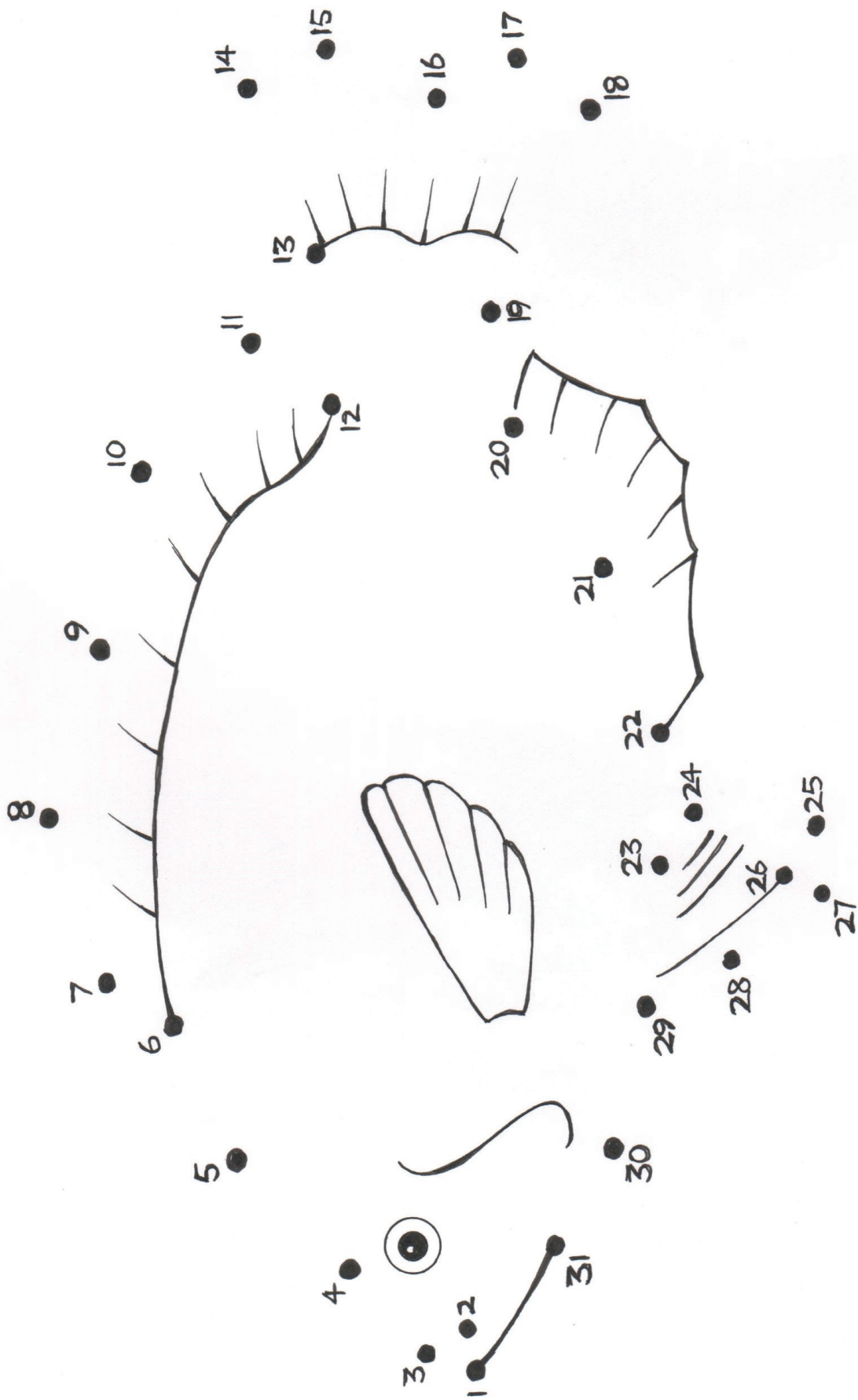



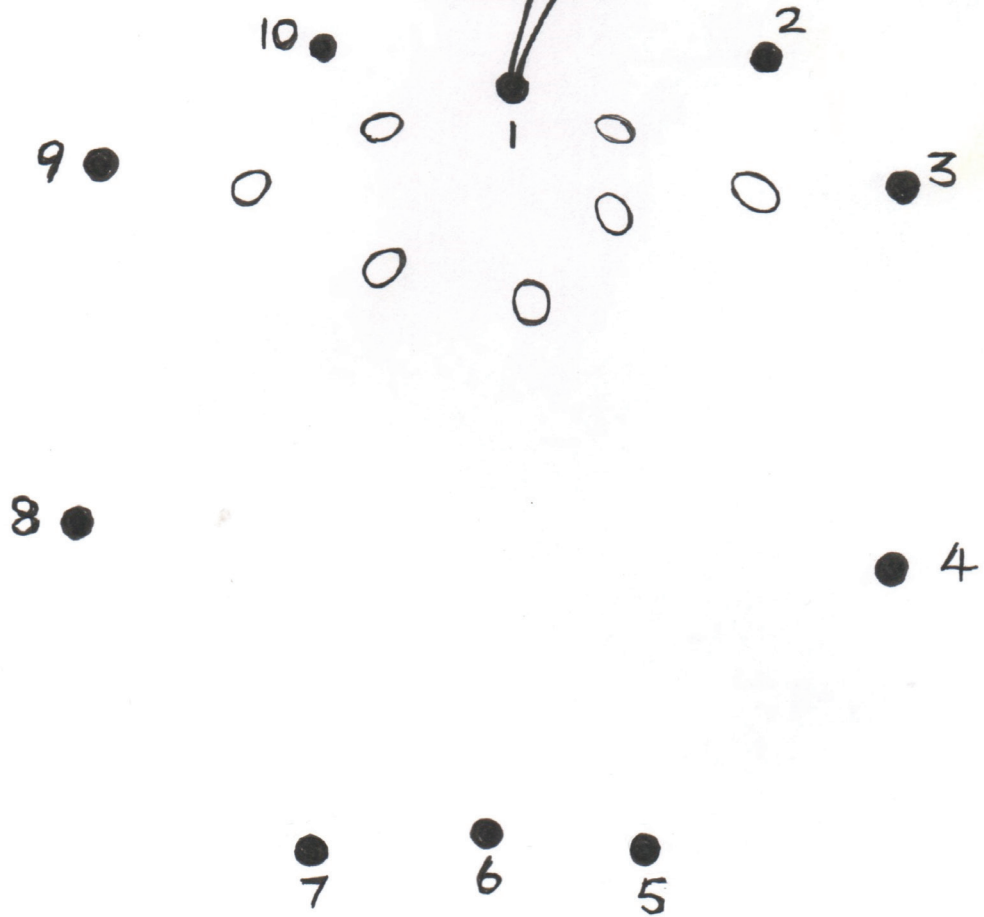

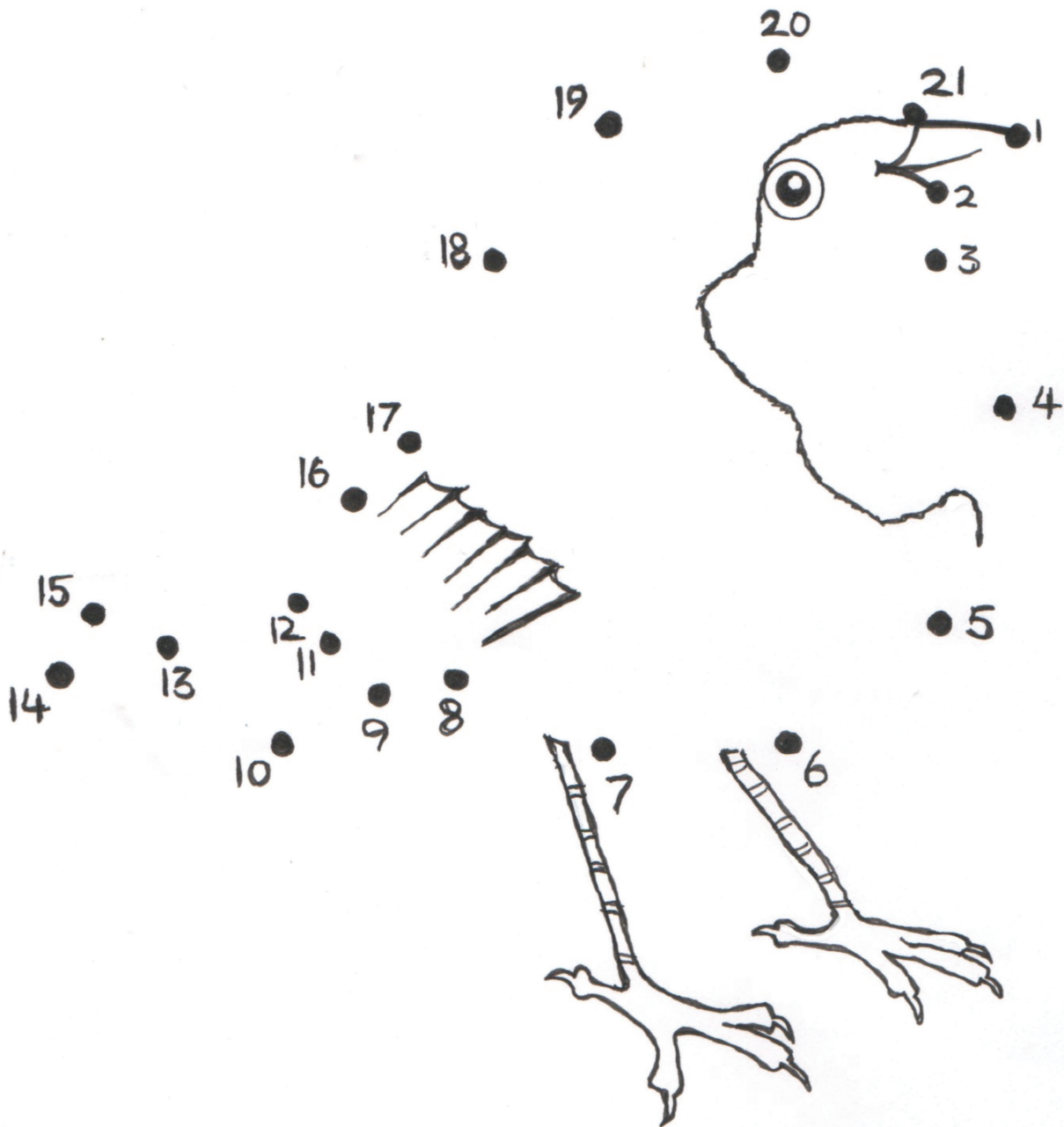

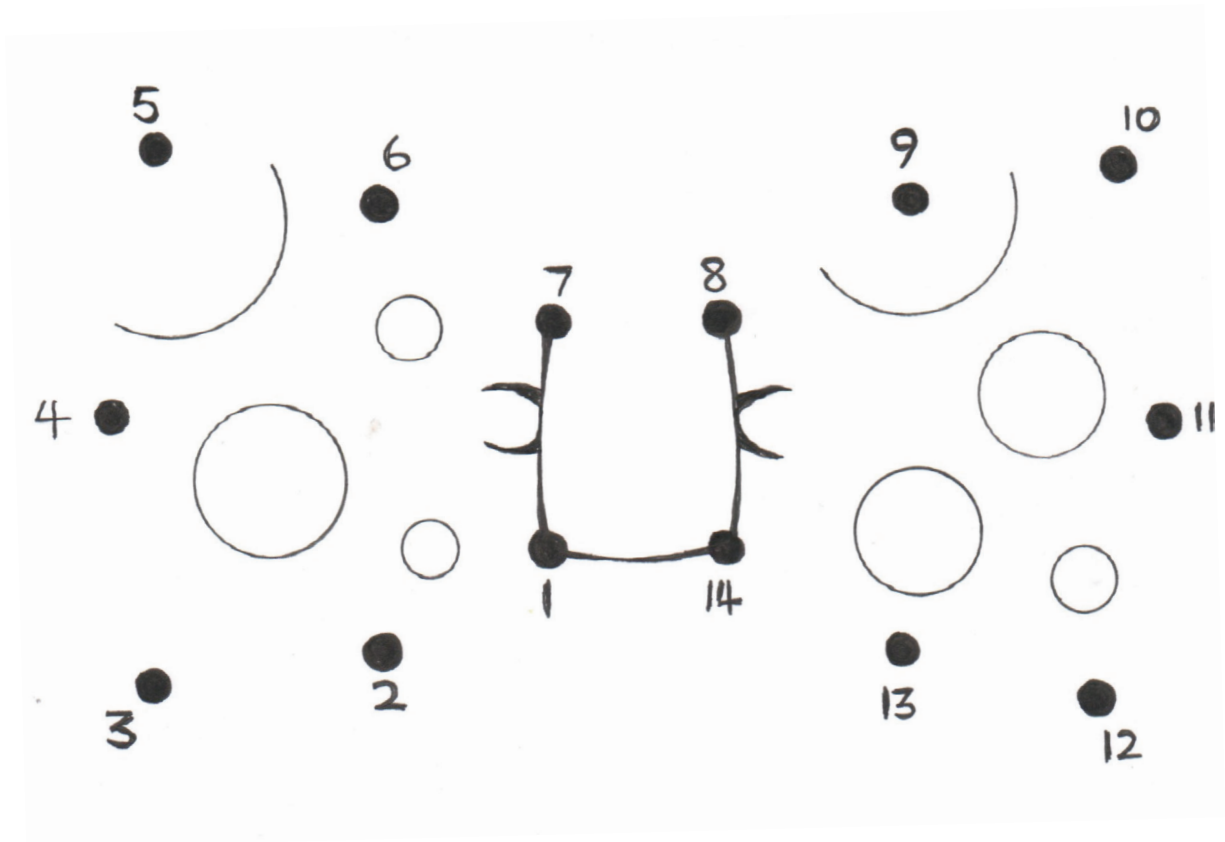

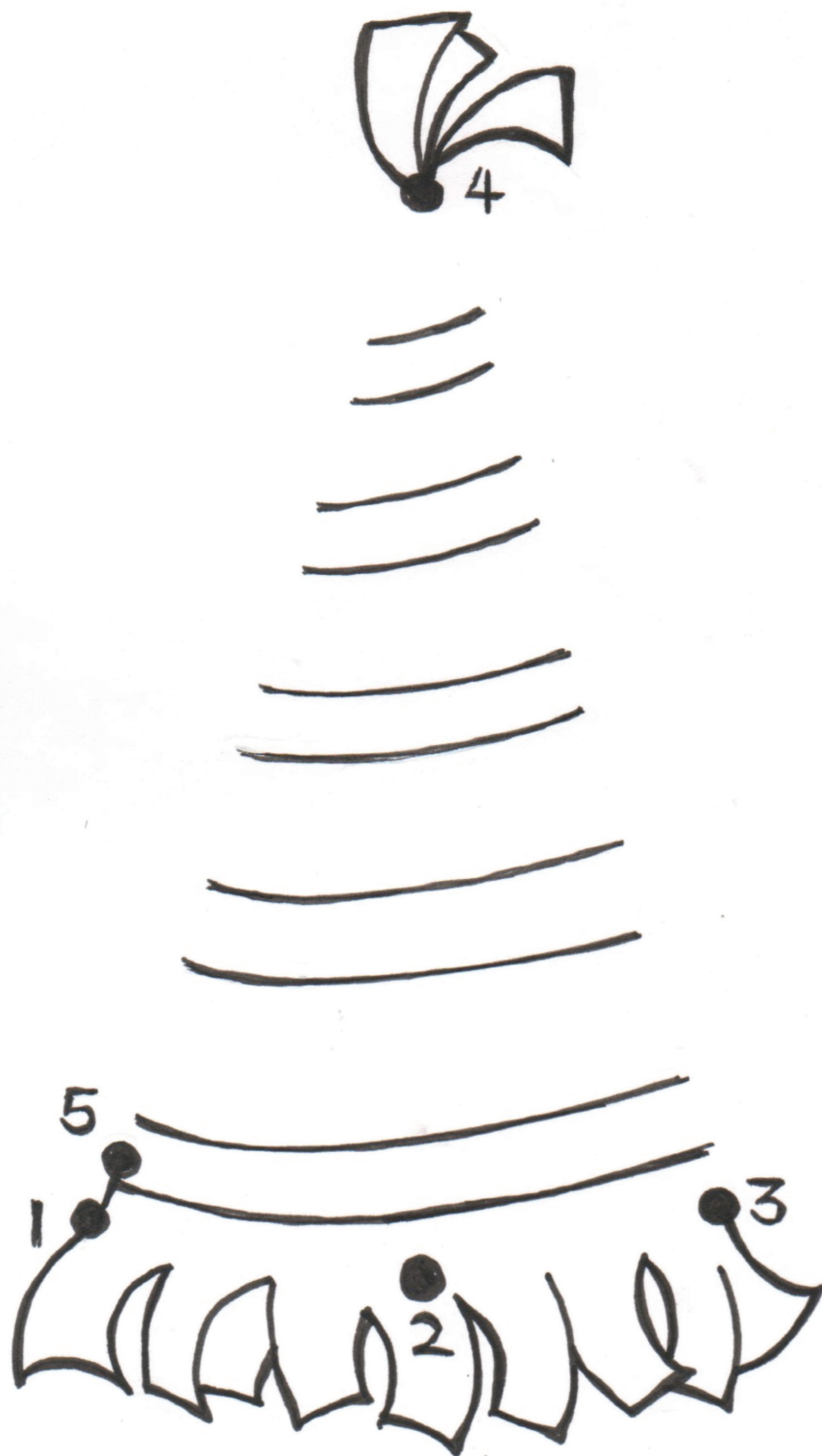

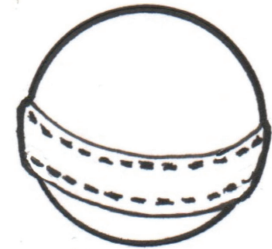
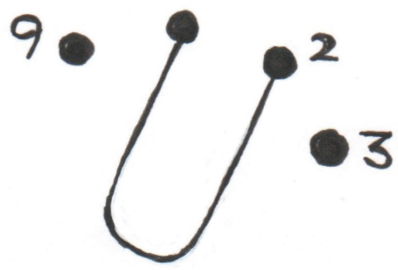
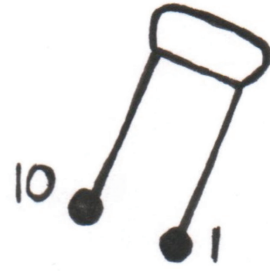

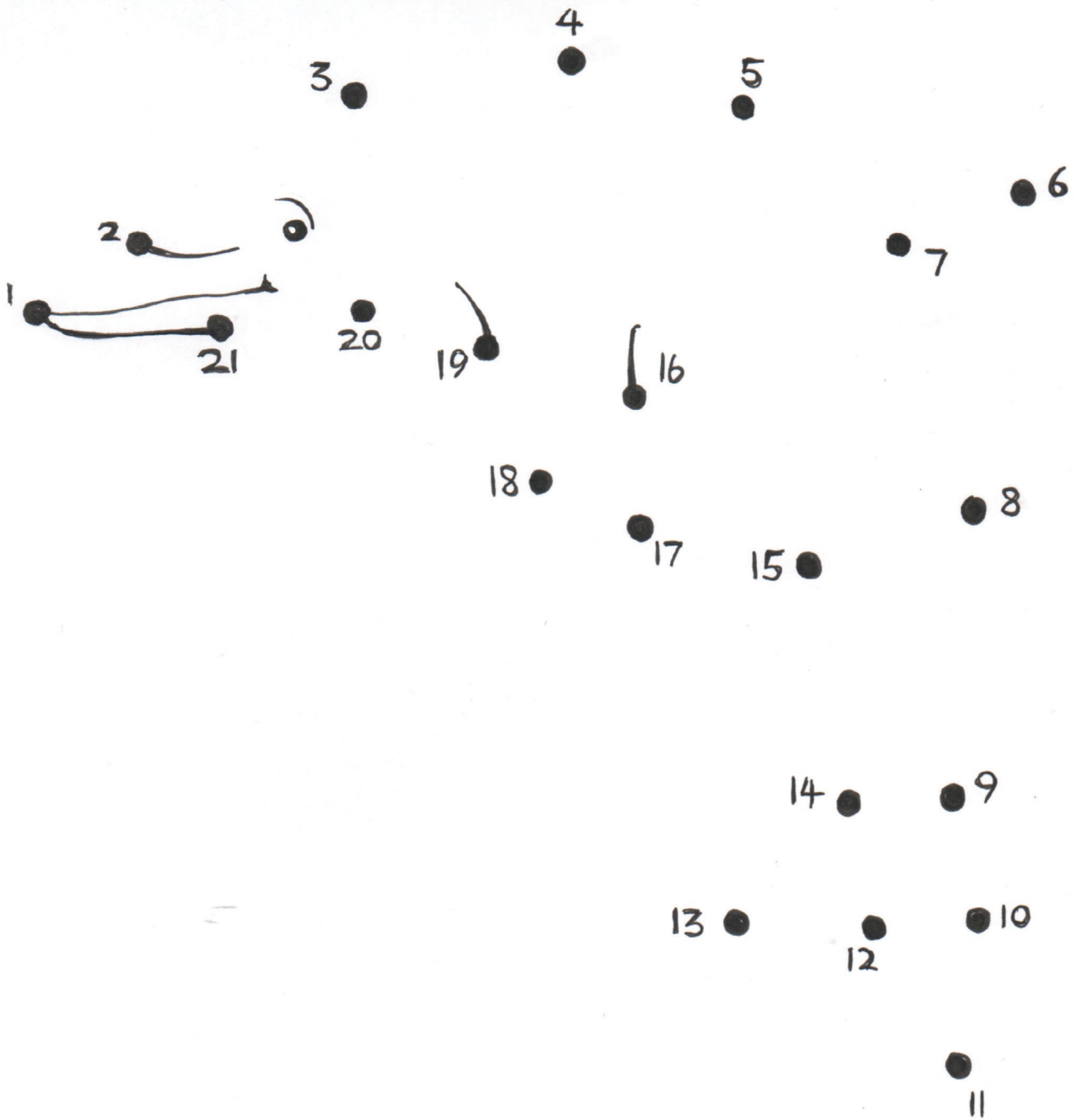

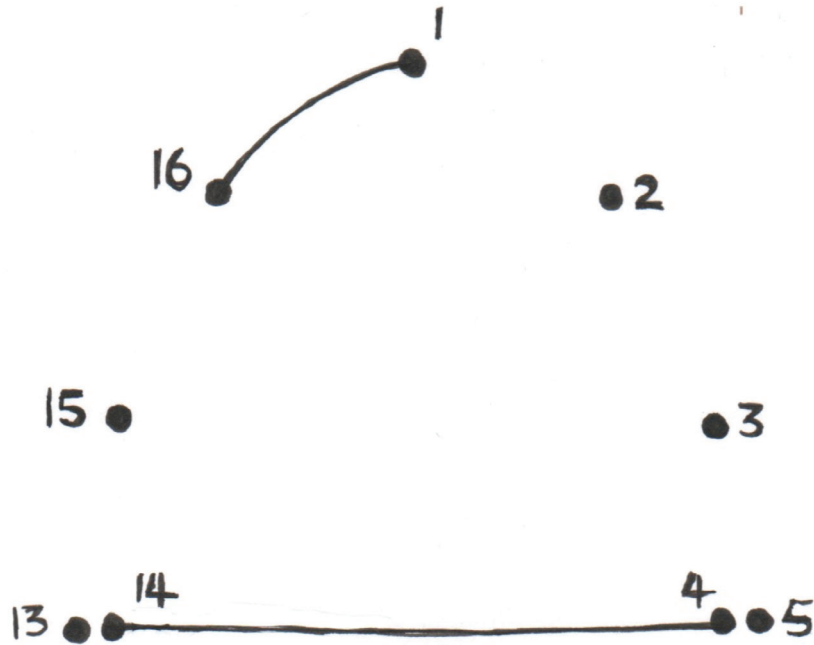



6 ● ● 7

5 ● ● 8

4 ● ● 9

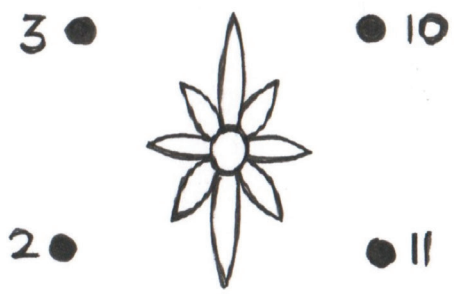

3 ●

● 10

2 ●

● 11



1 ●

● 12

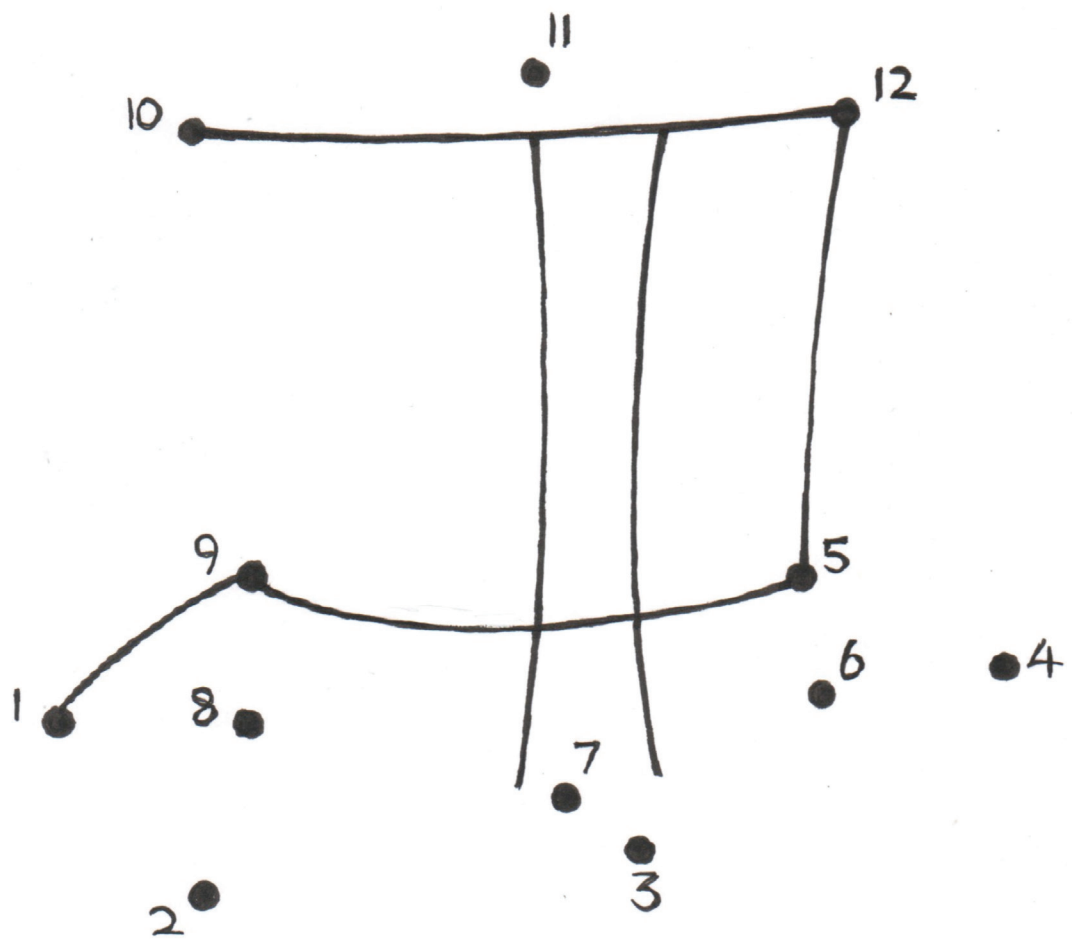

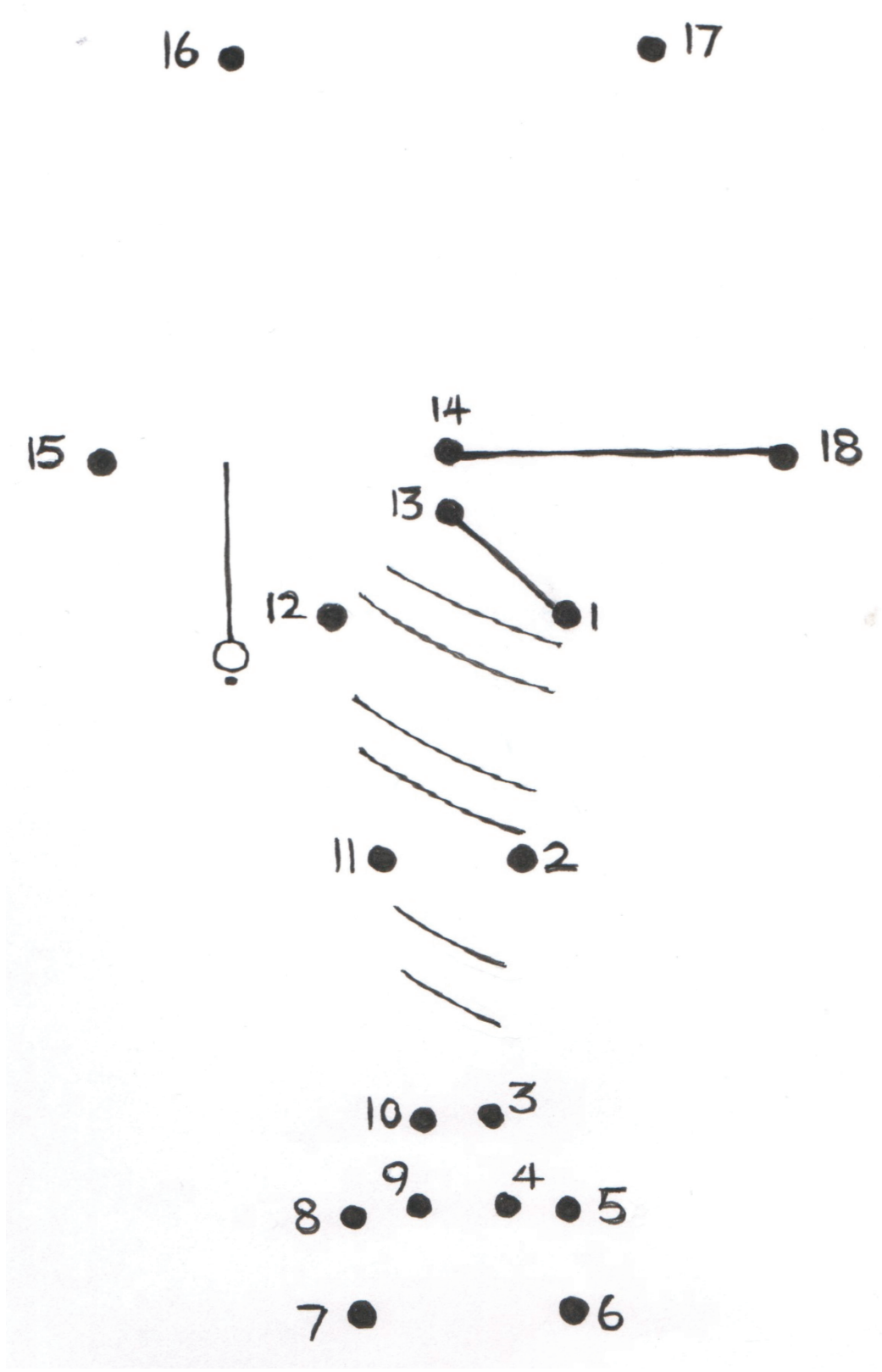

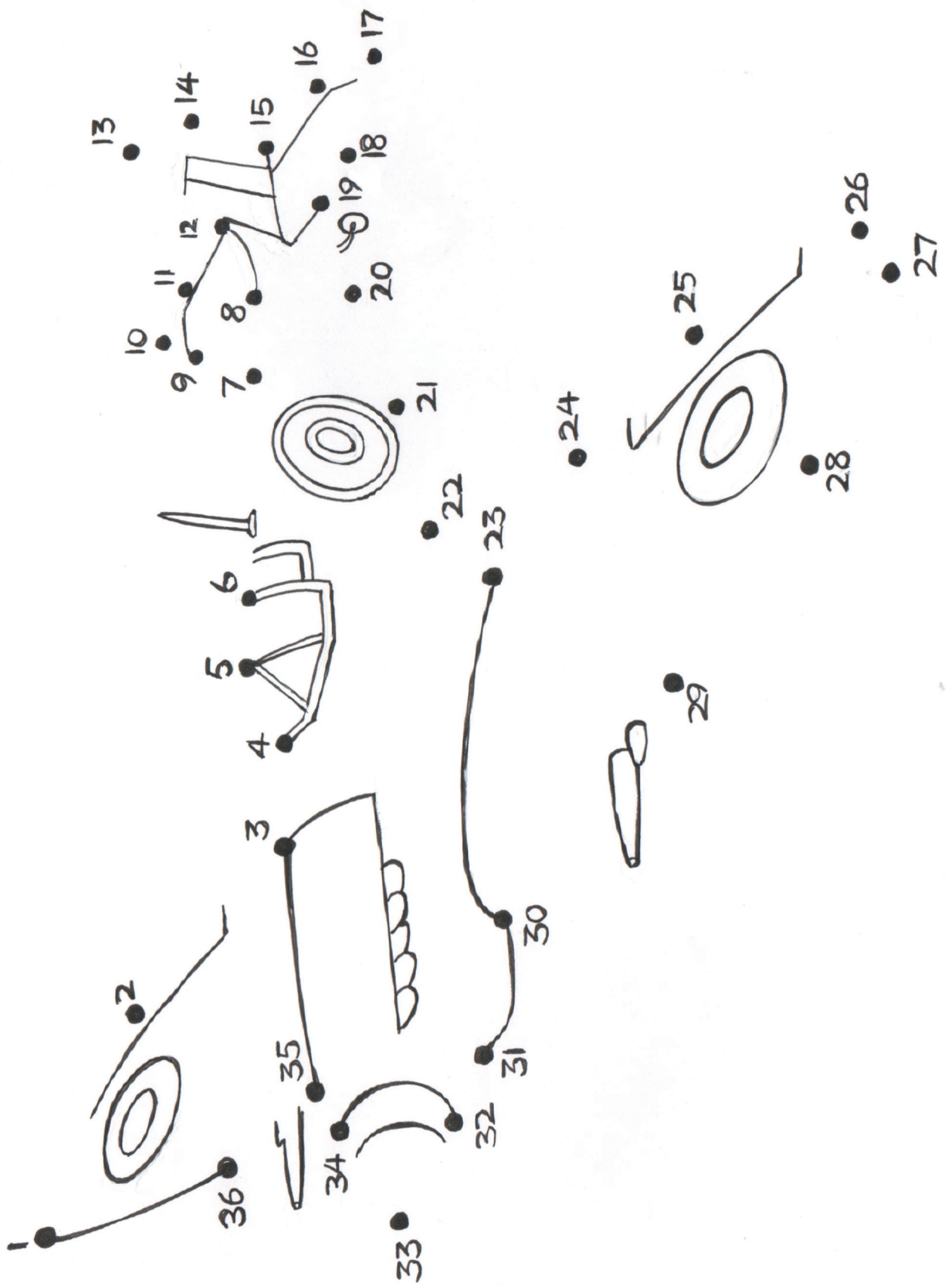

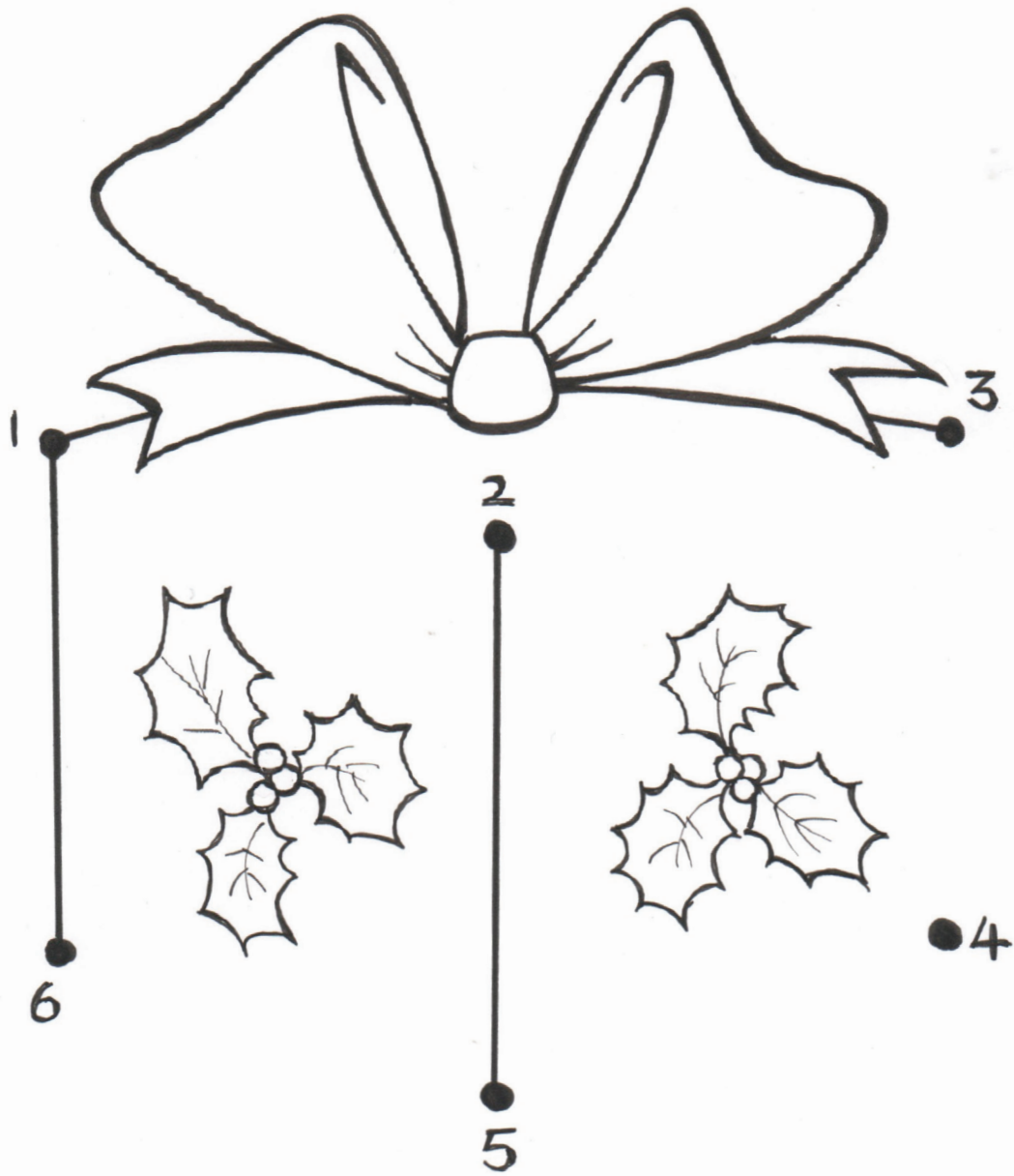



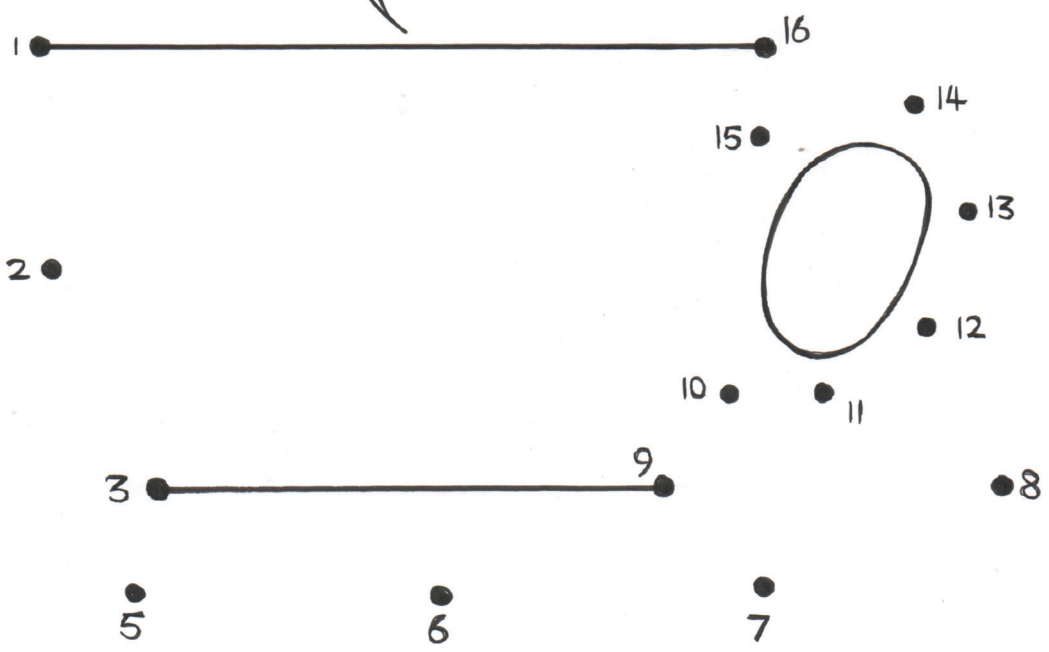

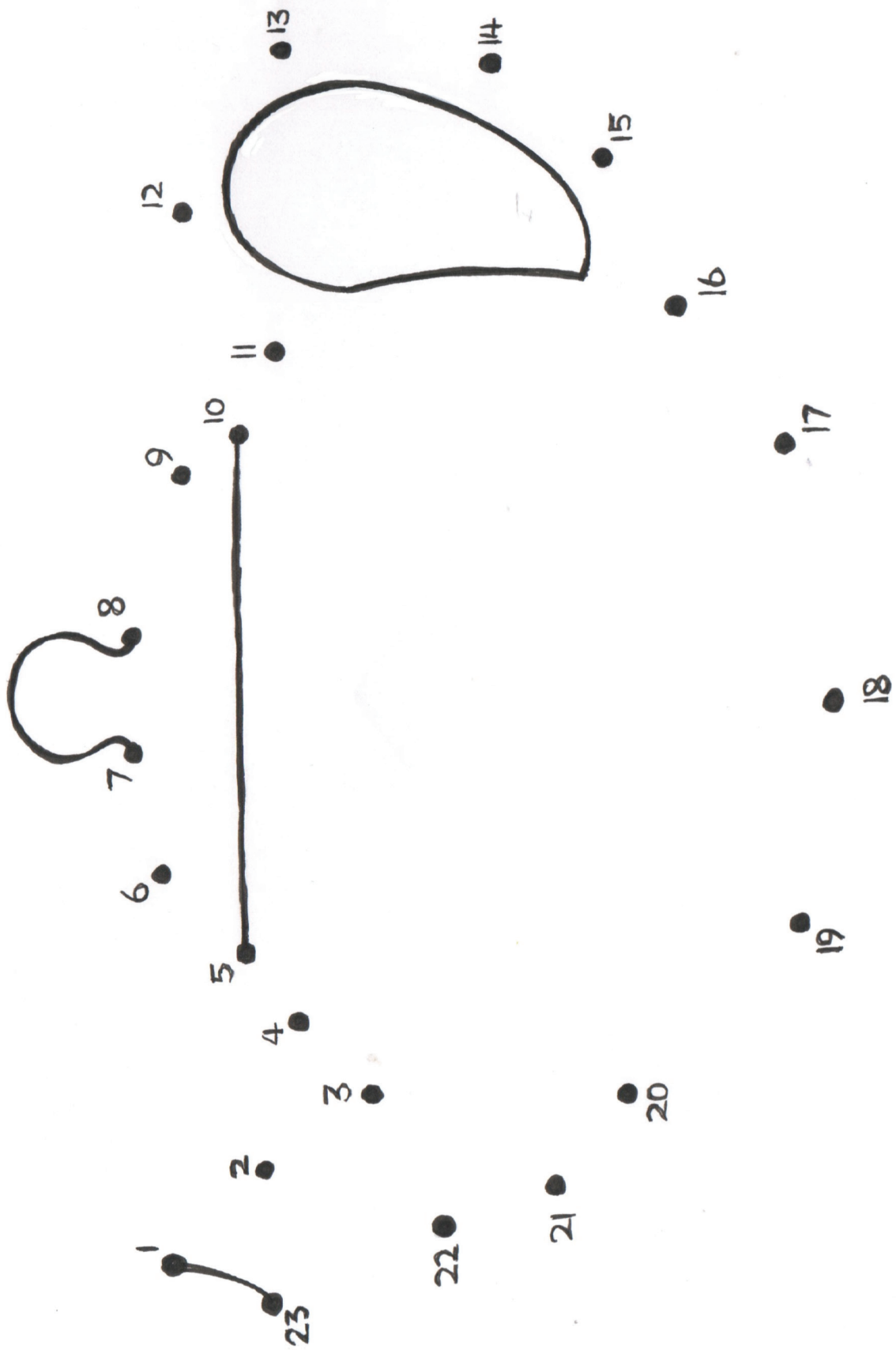

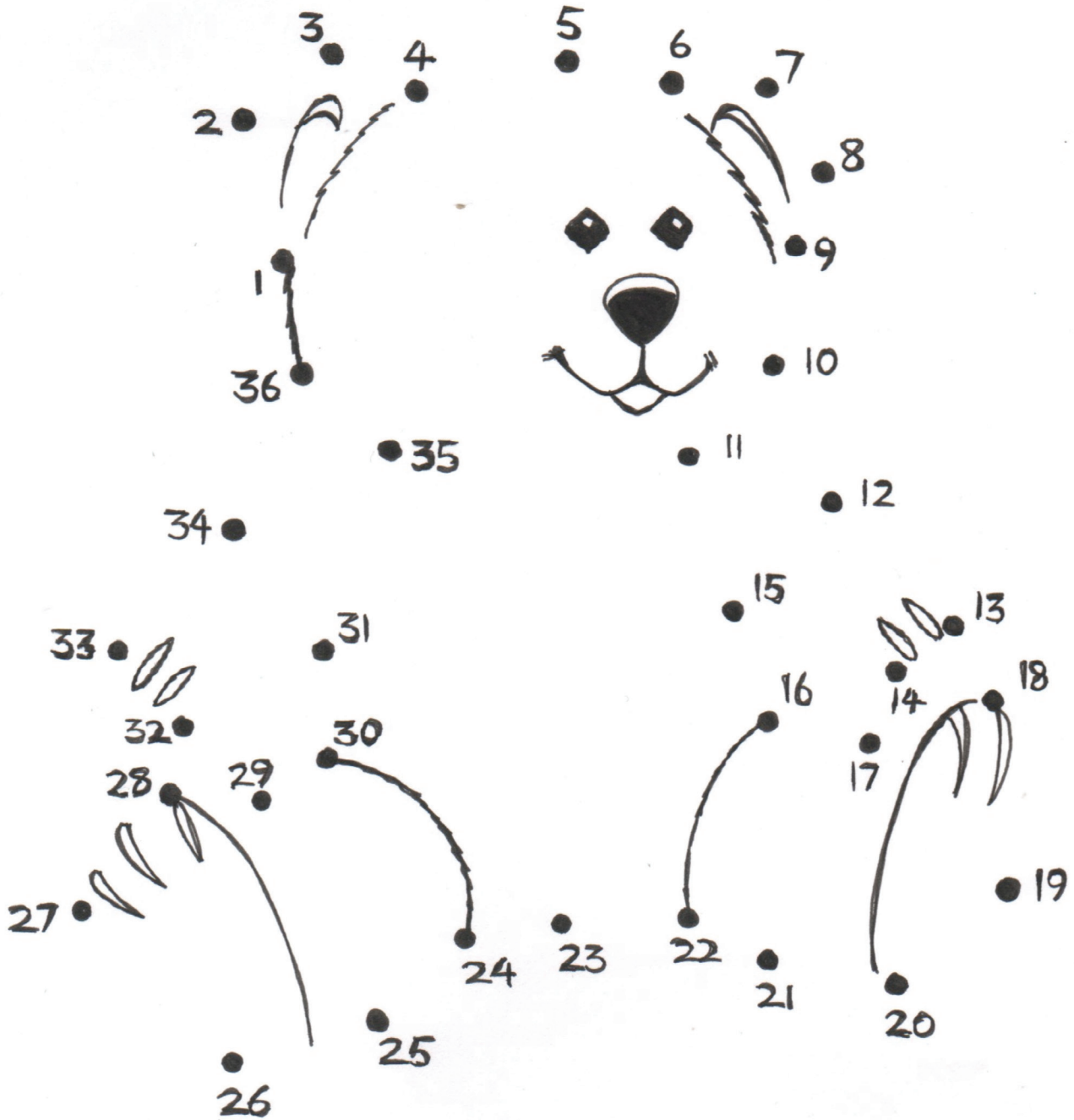

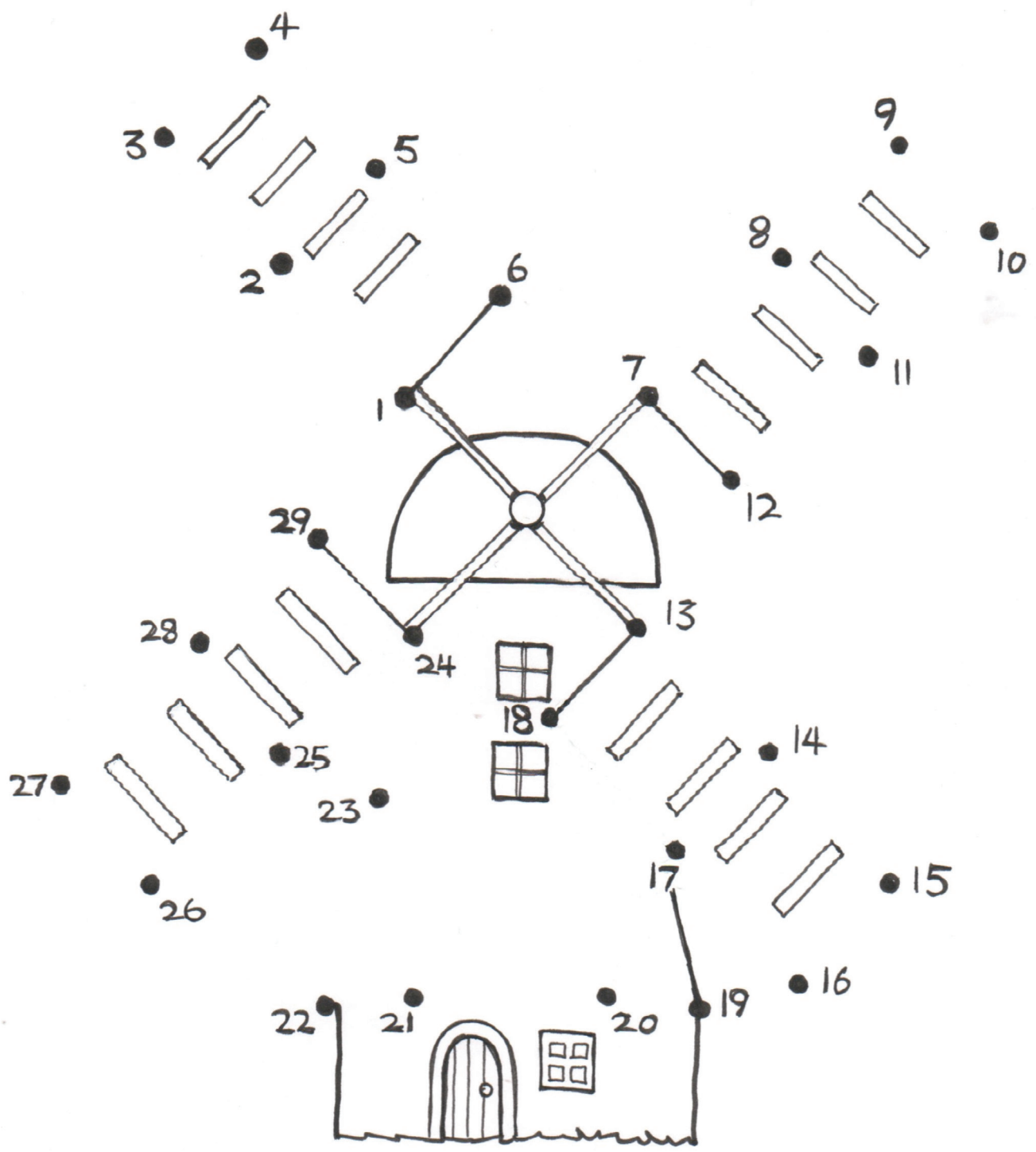

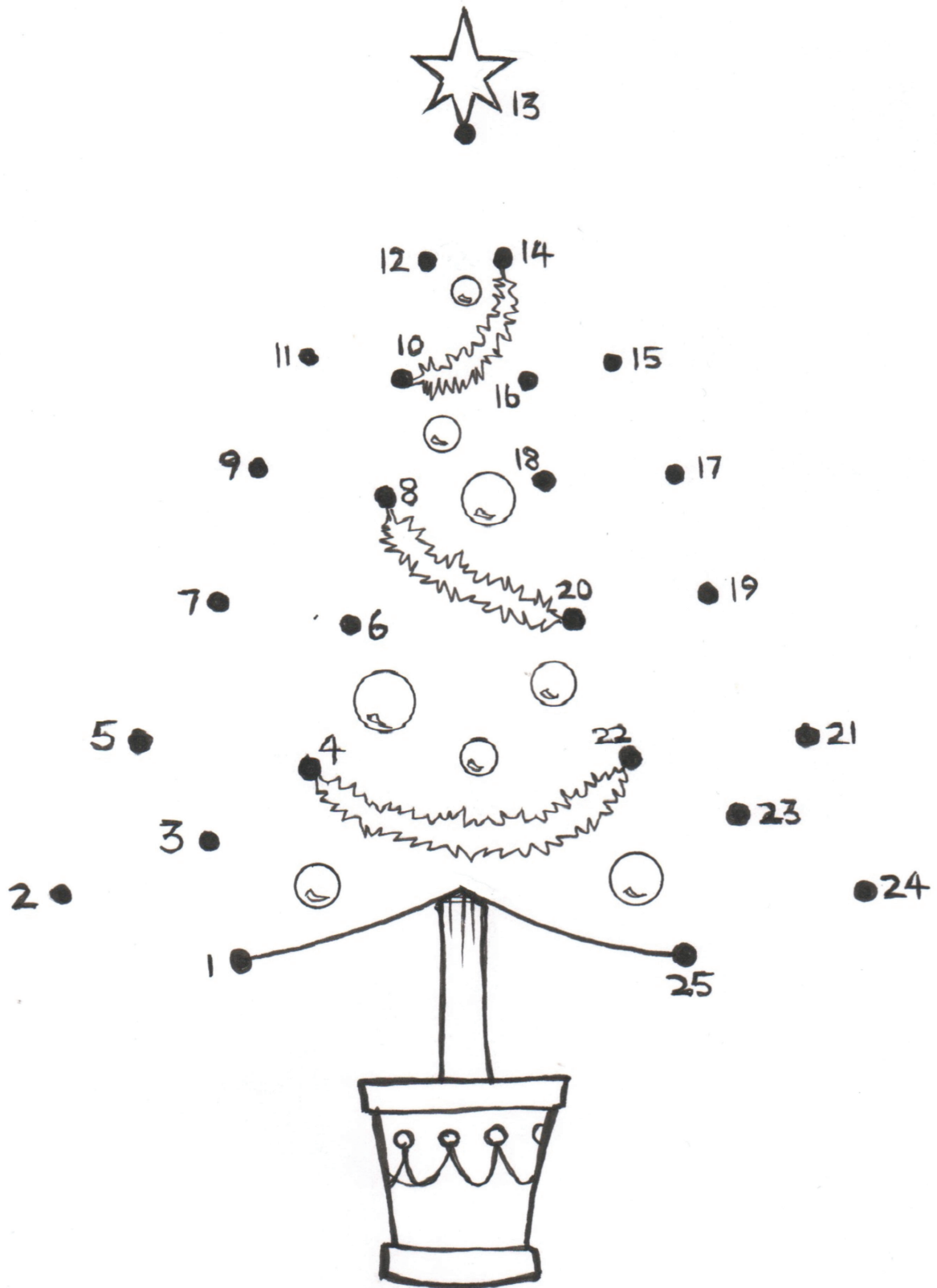

Match The Tools

Draw a line to match the tool with its name



Secateurs

Spade



Trowel

Fork



Rake

Watering Can



Match the Insect

A

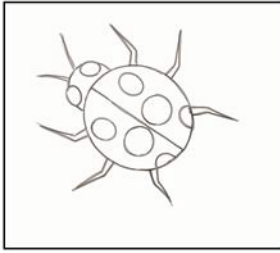

Beetle

B

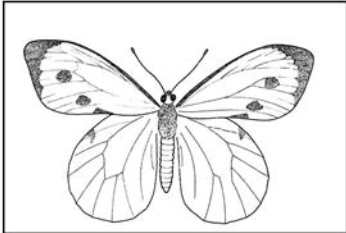

Mosquito

C

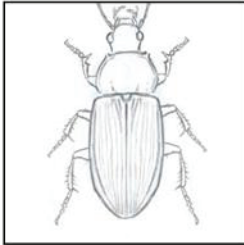

Spider

D

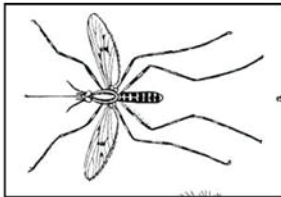

Ladybird

E

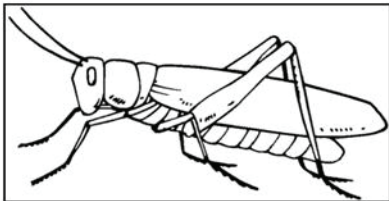

Butterfly

F

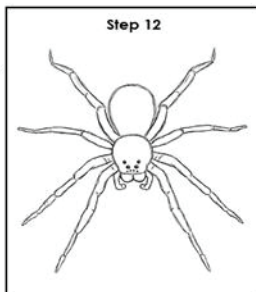

Grasshopper

Answers: A = Ladybird B = Butterfly C = Beetle D = Mosquito E = Grasshopper F = Spider

Scottish Quiz



1. Purple, shrubby bush growing on the hills.
2. Capital of Scotland.
3. This sport uses a heavy long pole.
4. Special name given to 25th January.
5. What are 'neeps' and 'tatties'?
6. Name of the pouch worn at the front of the kilt?
7. Name of the first king of Scotland?
8. Name the two most famous Scottish football teams.
9. Another name for the Scottish New Year celebrations.
10. What is traditionally worn under a kilt?
11. Name of a Scottish breakfast.
12. What does 'Mc' or 'Mac' mean?
13. Traditional Scottish alcoholic drink.
14. Famous wedding place for young couples.
15. Small dagger worn in socks in Scottish costume.
16. Famous military celebration.
17. Scottish national instrument.
18. What or who is 'Nessie'?
19. Where did Mary Queen of Scots live?
20. Another name for Scotland.

Answers:
1. Heather 2. Edinburgh 3. Caber tossing 4. Burns Night 5. Turnips and potatoes
6. Sporan 7. Robert the Bruce 8. Rangers and Celtic 9. Hogmanay 10. Nothing!
11. Porridge 12. Son of 13. Whisky 14. Gretna Green 15. SKEAN DHU 16. Edinburgh Tattoo

Summertime Quiz

Pit your wits against our holiday-themed quiz.

1. Television comedy 'Hi-de-Hi' was set in which fictional holiday camp?
a) Butlers b) Maplins c) Dixons
2. Which well known pop singer starred in 60's film 'Summer Holiday'?
a) Cliff Richard b) Elvis Presley c) Bill Haley
3. The 'Seven Sisters' is the name of which landmark in East Sussex?
a) Lakes b) Standing Stones c) Chalk Cliffs
4. 'Only Fools and Horses' TV comedy filmed at which popular seaside resort?
a) Clacton b) Margate c) Southend
5. Where did Billy Butlin open his first holiday camp in 1936?
a) Skegness b) Minehead c) Bognor Regis
6. Which pop act sang the 1970's hit 'In The Summertime'?
a) T-Rex b) Mungo Jerry c) Black Lace
7. Name of the first roller coaster ride at Blackpool?
a) Big Dipper b) Runaway Train c) Revolution
8. Which was the earliest king to enjoy ice cream in the UK?
a) Charles I b) Henry II c) Edward V
9. Which British seaside attraction is 158m tall?
a) Weymouth Pole b) Poole Lighthouse c) Blackpool Tower
10. ITV holiday show fronted by Judith Chalmers?
a) Fun in the Sun b) Wish You Were Here c) Holiday

Answers: 1. Maplins 2. Cliff Richard 3. Chalk Cliffs 4. Margate 5. Skegness
6. Mungo Jerry 7. Big Dipper 8. Charles I 9. Blackpool Tower 10. Wish You Were
Here

Wimbledon Quiz

1. In which year was the first men's championship held?
a) 1877 b) 1887 c) 1897
2. Which is the heaviest?
a) golf ball b) squash ball c) tennis ball
3. What is the name of the electronic eye at Wimbledon?
a) Tiger Eye b) Eagle Eye c) Hawk Eye
4. What score does 'Deuce' depict?
a) 30 all b) 40 all c) 50 all
5. Who is famous for saying 'You cannot be serious!'
a) Rafael Nadal b) Jimmy Connors c) John McEnroe
6. Which of the following is the postcode of Wimbledon?
a) SW19 b) SE19 c) NW19
7. Which fruity dessert is linked to the championships?
a) Cherries and cream b) Strawberries and cream
8. In which year did Andy Murray win the men's championship?
a) 2011 b) 2012 c) 2013
9. How high is the grass on court?
a) 6mm b) 8mm c) 10mm
10. What is the name of the main official judge?
a) captain b) referee c) umpire

Answers: 1 = 1877 2 = tennis ball 3 = Hawk Eye 4 = 40 all 5 = John McEnroe 6 = SW19
7 = strawberries and cream 8 = 2013 9 = 8mm 10 = umpire

Christmas Word Challenge

Draw a line to match the two halves together
to make a seasonal word

Chris	tide
sn	lph
ro	sel
st	lly
yule	ar
Rudo	bin
tin	owman
adv	tmas
ho	ent



u



p



d

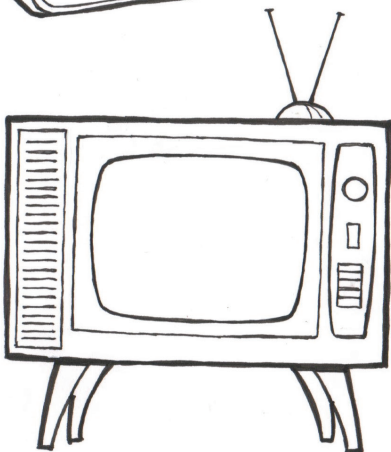

t

v



u

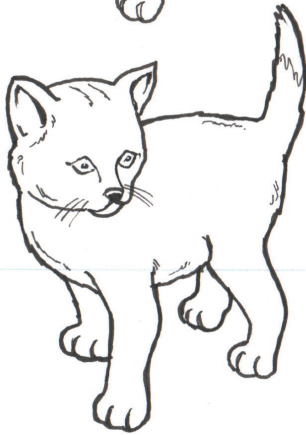

t

n



k

t



h

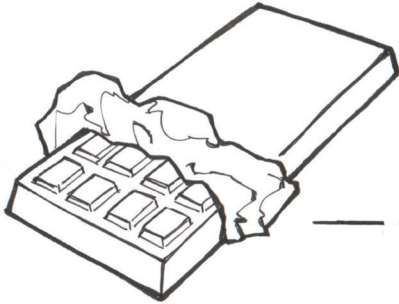

H

T



W

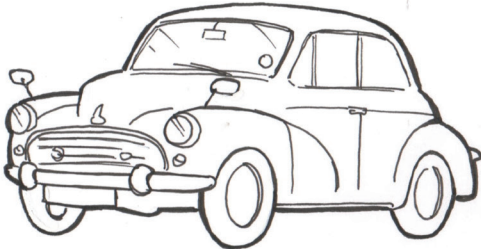

A

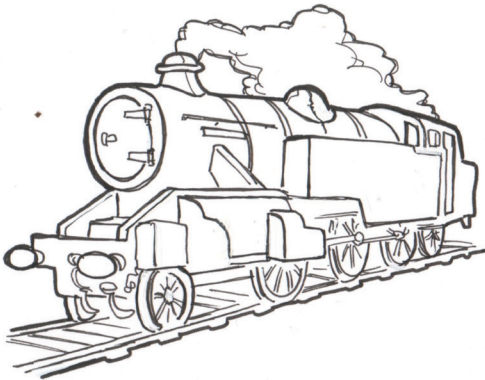

R

COLOURFUL SONG CROSSWORD

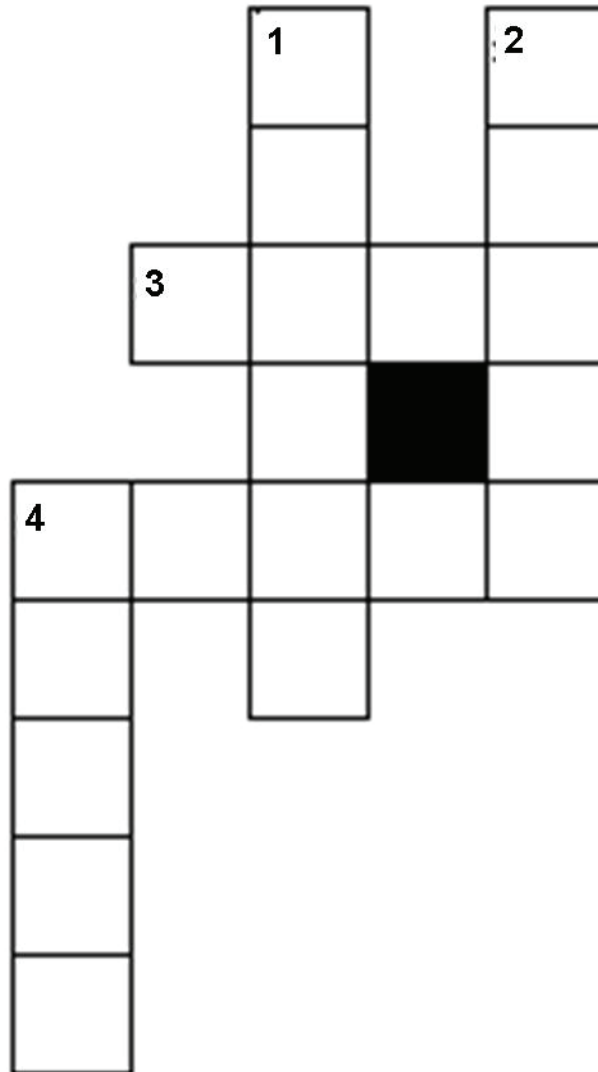

CLUES:

ACROSS:

3. _____ DANUBE

4. LITTLE ----- JUG

DOWN:

1. - _____ SUBMARINE

2. THERE IS A ----- HILL FAR AWAY

4. THAT OLD ----- MAGIC

Down: 1. Yellow 2. Green 4. Black

Across: 3. Blue 4. Brown

Answers:

Musical Memories Crossword

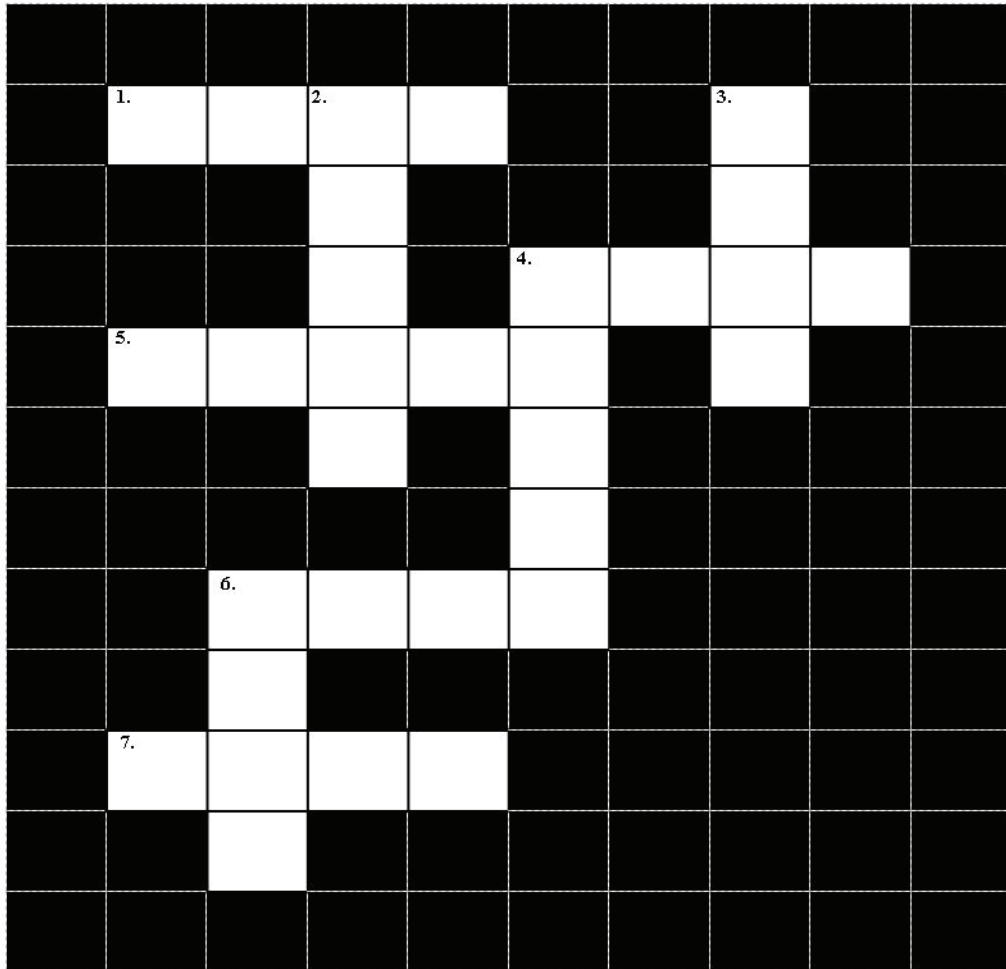

Across:

- 1. Show me the way to go _____ (4)
- 4. Raindrops keep falling on my _____ (4)
- 5. There'll be bluebirds over the _____ cliffs of Dover (5)
- 6. Pop _____ the weasel (4)
- 7. Whistle while you _____ (4)

Down:

- 2. The hills are alive with the sound of _____ (5)
- 3. Twinkle twinkle little _____ (4)
- 4. A spoonful of sugar _____ the medicine go down (5)
- 6. For he's a jolly _____ fellow (4)

Across: 1-home 4-head 5-white 6-goes 7-work Down: 2-music 3-star 4-helps 6-good

HARVEST WORD SEARCH

j e u q m i c t s e v r a h e
n a d i g h v d n j u r t r c
h f m r u g k g h f h s o x t
u a y t c s u j y e q t c z j
h w n s f v e g s j s n v n h
v e z v i z a n e w i e x g h
y i l l p l o u g h g s m f s
g a t h e r f d s e a b o r l
k a g j p h h w t h q h c i q
t c g m s i y a f a z l v d d
u i i t z b b e v r e s e r p
z j u p s l p r o d u c e g d
k f e r e h f h n p a e r i v
f y b s f a q t i c t s g t c
t h a n k s g i v i n g c s z

chutney

dig

fruit

gather

Harvest

jam

pick

plough

preserve

Produce

reap

store

thanksgiving

vegetables

REMEMBRANCE WORD SEARCH

A W P O P P Y N S L N R E U V Y H X U B
R E T L E H S A Q F M A Y M A Y P X X C
G A T H M X L M T F R R P B M N E X T U
N U Y R A T I L I M O I D S U O B U P Y
B O L P J A E R U T S E C R O F S K Q V
X O I G O Z B I S X F Q Z B O L H D R H
M R O T A Q S I N C Q Z Z E M K C Y W M
N T Q T A C H F S B C O O W W Z H V O J
I Q U Z S R T T S T Y S E N N T C S D M
I G D V Y K S W N Y R R J X J W E O P E
S B V M D Y C R D R Z J K C M W F Z V U
S Z M W Z M X N A V T K D A O A M W T Q
H O I N P A U P A Y U O O G B E R T C R
T C I M F N J X U K A J K Z I E Q D G H
P C N G Z U C V W P P V K J I Z N Y D Y
G P E E C D U C F O R D B D G C R E A P
Y K T S R B U J Q K A J L X X P K R C T
E Y V G P T B U U C Q O W D K S Z F I W
H O R S E B S X Y I S N X X V C H V E C
G E P N H P D R O O G X R K M Y J X P H

BOOTS

FORCES

HISTORY

HORSE

MILITARY

POPPY

RATION

SHELTER

SOLDIER

SOMME

TOMMY

TRENCH

Summer Word Search

h x d j q l w s a b
q o x i o k a u j u
e j l l x s t m e c
s b l i a x e m d k
u y e n d h r e i e
n t d s z a a r s t
y a s p h e y t a c
l h w a t y o y e h
i p m d x t l r s h
e w r e v a c x m k

bucket

hat

holiday

lolly

sandal

seaside

spade

summer

sun

water

Treats Word Search

P T Y O V E D F L S M U G E L B B U B J
P O O V U L N G T I S E W W A Y W D E X
P J P F P T O I E P L S G O J M L L T T
U J W I F C R E B E K A X U Q D L C X P
N Q N M L E B K R K H D I I U Y B L J K
E Q T U N L E A E I L M N J R X B S E I
H T D K H Y O C H U U J O C Y A M R I X
V Y X K D S M L S V J W A S D J I B O X
R L S D I Q N M B M H O C Y S L E O L M
N M W X H F X H Y B H T G C N Z O H E Z
E G V N S T R A T D H W H L M G L P N R
T O G D J L G J K F F O S S R H O T J I
P B W V A O D W L X C Q B T Y I I V K R
G S Z D V V J A J O C G P O N U Q S H V
Q T B O N B O N L T N O P E C I H R E O
Y O V Q R H T A G R P Y K S Z X M B C Z
X P J M F H T D T I W E I G J L O B G W
E P P N T E W W D F X B U O D Z H W Y T
W E S U D H E S U L B X Q X E G P F B J
I R G S L D U G N E A U N J Y E C K J I

CHOCOLATE

BUBBLEGUM

BISCUIT

TARTS

BONBON

SHERBET

CAKE

TRIFLE

TOFFEE

GOBSTOPPER

POP

LOLLIPOP

MINT

JELLY

FESTIVE CROSSWORD TEASER

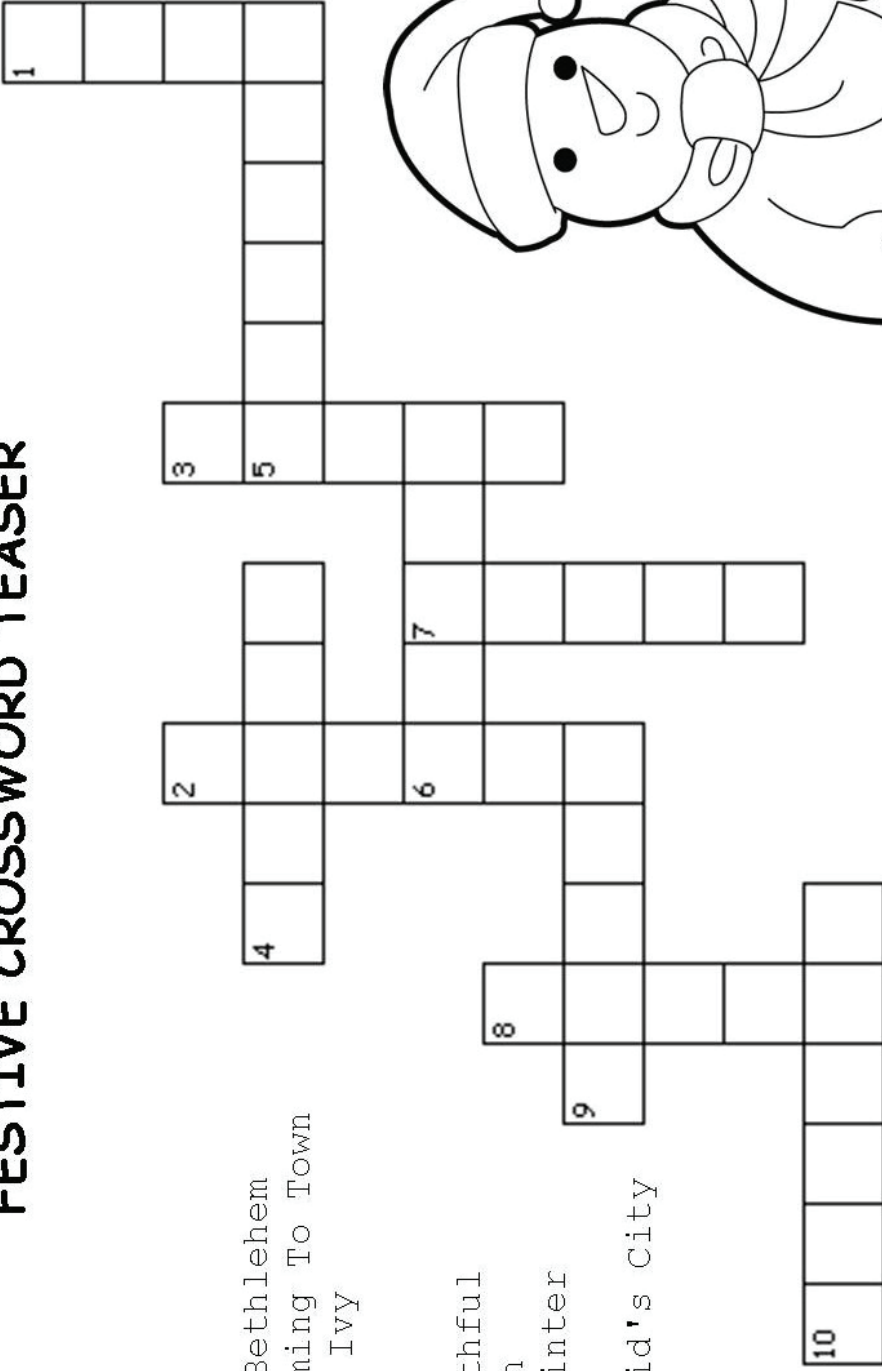

CLUES

Across

- 4. We ----- Kings
- 5. O ----- Town Of Bethlehem
- 6. ----- Claus Is Coming To Town
- 9. The ----- And The Ivy
- 10. ----- Bells

Down

- 1. O ----- All Ye Faithful
- 2. ----- The Snowman
- 3. In The ----- Midwinter
- 7. Silent -----
- 8. Once In ----- David's City

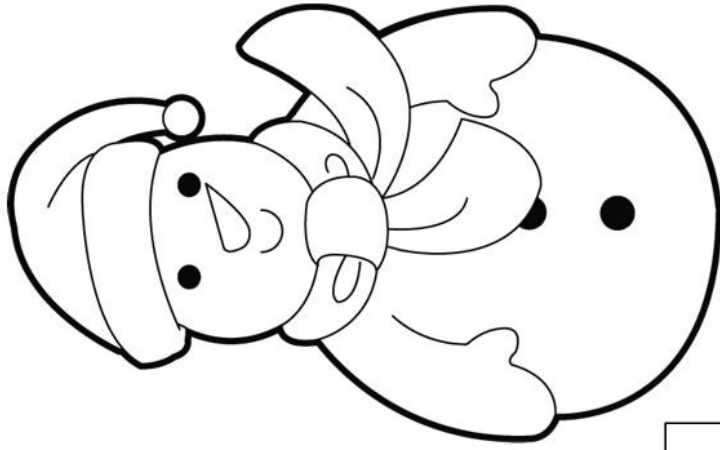

Answers: Across: 4. three 5. little 6. santa 9. holly 10. jingle Down: 1. come 2. frosty 3. bleak 7. night 8. royal

Additions

$$\begin{array}{r} 1 \\ + 6 \\ \hline \end{array}$$

$$\begin{array}{r} 4 \\ + 8 \\ \hline \end{array}$$

$$\begin{array}{r} 7 \\ + 2 \\ \hline \end{array}$$

$$\begin{array}{r} 9 \\ + 2 \\ \hline \end{array}$$

$$\begin{array}{r} 3 \\ + 6 \\ \hline \end{array}$$

$$\begin{array}{r} 1 \\ + 8 \\ \hline \end{array}$$

$$\begin{array}{r} 8 \\ + 4 \\ \hline \end{array}$$

$$\begin{array}{r} 7 \\ + 8 \\ \hline \end{array}$$

$$\begin{array}{r} 6 \\ + 6 \\ \hline \end{array}$$

$$\begin{array}{r} 10 \\ + 2 \\ \hline \end{array}$$

$$\begin{array}{r} 5 \\ + 4 \\ \hline \end{array}$$

$$\begin{array}{r} 15 \\ + 3 \\ \hline \end{array}$$

Additions

$$\begin{array}{r} 12 \\ + 6 \\ \hline \end{array}$$

$$\begin{array}{r} 11 \\ + 4 \\ \hline \end{array}$$

$$\begin{array}{r} 14 \\ + 2 \\ \hline \end{array}$$

$$\begin{array}{r} 16 \\ + 3 \\ \hline \end{array}$$

$$\begin{array}{r} 20 \\ + 5 \\ \hline \end{array}$$

$$\begin{array}{r} 17 \\ + 8 \\ \hline \end{array}$$

$$\begin{array}{r} 38 \\ + 11 \\ \hline \end{array}$$

$$\begin{array}{r} 62 \\ + 24 \\ \hline \end{array}$$

$$\begin{array}{r} 91 \\ + 53 \\ \hline \end{array}$$

$$\begin{array}{r} 76 \\ + 13 \\ \hline \end{array}$$

$$\begin{array}{r} 49 \\ + 30 \\ \hline \end{array}$$

$$\begin{array}{r} 38 \\ + 75 \\ \hline \end{array}$$

Additions

$$\begin{array}{r} 1 \\ + 7 \\ \hline \end{array}$$

$$\begin{array}{r} 9 \\ + 4 \\ \hline \end{array}$$

$$\begin{array}{r} 4 \\ + 7 \\ \hline \end{array}$$

$$\begin{array}{r} 9 \\ + 6 \\ \hline \end{array}$$

$$\begin{array}{r} 2 \\ + 3 \\ \hline \end{array}$$

$$\begin{array}{r} 3 \\ + 1 \\ \hline \end{array}$$

$$\begin{array}{r} 8 \\ + 3 \\ \hline \end{array}$$

$$\begin{array}{r} 1 \\ + 7 \\ \hline \end{array}$$

$$\begin{array}{r} 4 \\ + 4 \\ \hline \end{array}$$

$$\begin{array}{r} 7 \\ + 10 \\ \hline \end{array}$$

$$\begin{array}{r} 6 \\ + 5 \\ \hline \end{array}$$

$$\begin{array}{r} 12 \\ + 7 \\ \hline \end{array}$$

Additions

$$\begin{array}{r} 14 \\ + 8 \\ \hline \end{array}$$

$$\begin{array}{r} 22 \\ + 6 \\ \hline \end{array}$$

$$\begin{array}{r} 17 \\ + 2 \\ \hline \end{array}$$

$$\begin{array}{r} 19 \\ + 3 \\ \hline \end{array}$$

$$\begin{array}{r} 30 \\ + 6 \\ \hline \end{array}$$

$$\begin{array}{r} 12 \\ + 2 \\ \hline \end{array}$$

$$\begin{array}{r} 39 \\ + 18 \\ \hline \end{array}$$

$$\begin{array}{r} 29 \\ + 16 \\ \hline \end{array}$$

$$\begin{array}{r} 31 \\ + 29 \\ \hline \end{array}$$

$$\begin{array}{r} 19 \\ + 18 \\ \hline \end{array}$$

$$\begin{array}{r} 16 \\ + 24 \\ \hline \end{array}$$

$$\begin{array}{r} 14 \\ + 38 \\ \hline \end{array}$$

Additions

$$\begin{array}{r} 14 \\ + 20 \\ \hline \end{array}$$

$$\begin{array}{r} 31 \\ + 49 \\ \hline \end{array}$$

$$\begin{array}{r} 24 \\ + 39 \\ \hline \end{array}$$

$$\begin{array}{r} 18 \\ + 37 \\ \hline \end{array}$$

$$\begin{array}{r} 9 \\ + 48 \\ \hline \end{array}$$

$$\begin{array}{r} 11 \\ + 10 \\ \hline \end{array}$$

$$\begin{array}{r} 3 \\ + 29 \\ \hline \end{array}$$

$$\begin{array}{r} 19 \\ + 16 \\ \hline \end{array}$$

$$\begin{array}{r} 28 \\ + 38 \\ \hline \end{array}$$

$$\begin{array}{r} 10 \\ + 40 \\ \hline \end{array}$$

$$\begin{array}{r} 17 \\ + 28 \\ \hline \end{array}$$

$$\begin{array}{r} 33 \\ + 44 \\ \hline \end{array}$$

Additions

$$\begin{array}{r} 59 \\ + 62 \\ \hline \end{array}$$

$$\begin{array}{r} 71 \\ + 45 \\ \hline \end{array}$$

$$\begin{array}{r} 83 \\ + 28 \\ \hline \end{array}$$

$$\begin{array}{r} 63 \\ + 95 \\ \hline \end{array}$$

$$\begin{array}{r} 75 \\ + 25 \\ \hline \end{array}$$

$$\begin{array}{r} 90 \\ + 33 \\ \hline \end{array}$$

$$\begin{array}{r} 62 \\ + 100 \\ \hline \end{array}$$

$$\begin{array}{r} 57 \\ + 603 \\ \hline \end{array}$$

$$\begin{array}{r} 28 \\ + 225 \\ \hline \end{array}$$

$$\begin{array}{r} 36 \\ + 266 \\ \hline \end{array}$$

$$\begin{array}{r} 30 \\ + 108 \\ \hline \end{array}$$

$$\begin{array}{r} 77 \\ + 333 \\ \hline \end{array}$$

Additions

$$\begin{array}{r} 202 \\ + 402 \\ \hline \end{array}$$

$$\begin{array}{r} 667 \\ + 135 \\ \hline \end{array}$$

$$\begin{array}{r} 118 \\ + 222 \\ \hline \end{array}$$

$$\begin{array}{r} 551 \\ + 550 \\ \hline \end{array}$$

$$\begin{array}{r} 267 \\ + 110 \\ \hline \end{array}$$

$$\begin{array}{r} 442 \\ + 695 \\ \hline \end{array}$$

$$\begin{array}{r} 738 \\ + 867 \\ \hline \end{array}$$

$$\begin{array}{r} 319 \\ + 478 \\ \hline \end{array}$$

$$\begin{array}{r} 963 \\ + 109 \\ \hline \end{array}$$

$$\begin{array}{r} 165 \\ + 744 \\ \hline \end{array}$$

$$\begin{array}{r} 651 \\ + 111 \\ \hline \end{array}$$

$$\begin{array}{r} 117 \\ + 990 \\ \hline \end{array}$$

Subtractions

$$\begin{array}{r} 4 \\ - 3 \\ \hline \end{array}$$

$$\begin{array}{r} 5 \\ - 3 \\ \hline \end{array}$$

$$\begin{array}{r} 4 \\ - 1 \\ \hline \end{array}$$

$$\begin{array}{r} 7 \\ - 6 \\ \hline \end{array}$$

$$\begin{array}{r} 3 \\ - 2 \\ \hline \end{array}$$

$$\begin{array}{r} 6 \\ - 2 \\ \hline \end{array}$$

$$\begin{array}{r} 9 \\ - 8 \\ \hline \end{array}$$

$$\begin{array}{r} 2 \\ - 0 \\ \hline \end{array}$$

$$\begin{array}{r} 8 \\ - 6 \\ \hline \end{array}$$

$$\begin{array}{r} 6 \\ - 4 \\ \hline \end{array}$$

$$\begin{array}{r} 7 \\ - 7 \\ \hline \end{array}$$

$$\begin{array}{r} 9 \\ - 5 \\ \hline \end{array}$$

Subtractions

$$\begin{array}{r} 6 \\ - 3 \\ \hline \end{array}$$

$$\begin{array}{r} 5 \\ - 1 \\ \hline \end{array}$$

$$\begin{array}{r} 8 \\ - 7 \\ \hline \end{array}$$

$$\begin{array}{r} 7 \\ - 2 \\ \hline \end{array}$$

$$\begin{array}{r} 4 \\ - 3 \\ \hline \end{array}$$

$$\begin{array}{r} 9 \\ - 9 \\ \hline \end{array}$$

$$\begin{array}{r} 11 \\ - 7 \\ \hline \end{array}$$

$$\begin{array}{r} 13 \\ - 4 \\ \hline \end{array}$$

$$\begin{array}{r} 10 \\ - 8 \\ \hline \end{array}$$

$$\begin{array}{r} 15 \\ - 5 \\ \hline \end{array}$$

$$\begin{array}{r} 12 \\ - 9 \\ \hline \end{array}$$

$$\begin{array}{r} 14 \\ - 5 \\ \hline \end{array}$$

Subtractions

$$\begin{array}{r} 10 \\ - 4 \\ \hline \end{array}$$

$$\begin{array}{r} 15 \\ - 2 \\ \hline \end{array}$$

$$\begin{array}{r} 12 \\ - 7 \\ \hline \end{array}$$

$$\begin{array}{r} 13 \\ - 8 \\ \hline \end{array}$$

$$\begin{array}{r} 10 \\ - 9 \\ \hline \end{array}$$

$$\begin{array}{r} 28 \\ - 11 \\ \hline \end{array}$$

$$\begin{array}{r} 35 \\ - 12 \\ \hline \end{array}$$

$$\begin{array}{r} 48 \\ - 25 \\ \hline \end{array}$$

$$\begin{array}{r} 19 \\ - 8 \\ \hline \end{array}$$

$$\begin{array}{r} 50 \\ - 35 \\ \hline \end{array}$$

$$\begin{array}{r} 17 \\ - 10 \\ \hline \end{array}$$

$$\begin{array}{r} 37 \\ - 22 \\ \hline \end{array}$$

Subtractions

$$\begin{array}{r} 52 \\ - 11 \\ \hline \end{array}$$

$$\begin{array}{r} 61 \\ - 17 \\ \hline \end{array}$$

$$\begin{array}{r} 74 \\ - 25 \\ \hline \end{array}$$

$$\begin{array}{r} 69 \\ - 33 \\ \hline \end{array}$$

$$\begin{array}{r} 77 \\ - 23 \\ \hline \end{array}$$

$$\begin{array}{r} 85 \\ - 11 \\ \hline \end{array}$$

$$\begin{array}{r} 32 \\ - 16 \\ \hline \end{array}$$

$$\begin{array}{r} 51 \\ - 31 \\ \hline \end{array}$$

$$\begin{array}{r} 80 \\ - 76 \\ \hline \end{array}$$

$$\begin{array}{r} 99 \\ - 13 \\ \hline \end{array}$$

$$\begin{array}{r} 87 \\ - 12 \\ \hline \end{array}$$

$$\begin{array}{r} 59 \\ - 41 \\ \hline \end{array}$$

Subtractions

$$\begin{array}{r} 258 \\ - 32 \\ \hline \end{array}$$

$$\begin{array}{r} 183 \\ - 94 \\ \hline \end{array}$$

$$\begin{array}{r} 325 \\ - 50 \\ \hline \end{array}$$

$$\begin{array}{r} 790 \\ - 220 \\ \hline \end{array}$$

$$\begin{array}{r} 383 \\ - 123 \\ \hline \end{array}$$

$$\begin{array}{r} 279 \\ - 144 \\ \hline \end{array}$$

$$\begin{array}{r} 631 \\ - 522 \\ \hline \end{array}$$

$$\begin{array}{r} 257 \\ - 239 \\ \hline \end{array}$$

$$\begin{array}{r} 415 \\ - 101 \\ \hline \end{array}$$

$$\begin{array}{r} 900 \\ - 661 \\ \hline \end{array}$$

$$\begin{array}{r} 147 \\ - 123 \\ \hline \end{array}$$

$$\begin{array}{r} 869 \\ - 593 \\ \hline \end{array}$$

Subtractions

$$\begin{array}{r} 742 \\ - 415 \\ \hline \end{array}$$

$$\begin{array}{r} 345 \\ - 225 \\ \hline \end{array}$$

$$\begin{array}{r} 487 \\ - 121 \\ \hline \end{array}$$

$$\begin{array}{r} 999 \\ - 668 \\ \hline \end{array}$$

$$\begin{array}{r} 230 \\ - 115 \\ \hline \end{array}$$

$$\begin{array}{r} 896 \\ - 167 \\ \hline \end{array}$$

$$\begin{array}{r} 701 \\ - 466 \\ \hline \end{array}$$

$$\begin{array}{r} 902 \\ - 316 \\ \hline \end{array}$$

$$\begin{array}{r} 222 \\ - 112 \\ \hline \end{array}$$

$$\begin{array}{r} 799 \\ - 331 \\ \hline \end{array}$$

$$\begin{array}{r} 427 \\ - 128 \\ \hline \end{array}$$

$$\begin{array}{r} 169 \\ - 115 \\ \hline \end{array}$$